



# hmi

high-accuracy  
measurement  
instruments

FICHA TÉCNICA DE PRODUTO

PRODUCT DATASHEET

---

**HMI – Automação e Instrumentação, Lda.**

---

Travessa da Indústria, nº 111  
4780-573 Santo Tirso  
PORTUGAL

Tel. +351 252 850 501  
Fax. +351 300 013 487

Web: [www.hmi.pt](http://www.hmi.pt)

Email: [hmi@hmi.pt](mailto:hmi@hmi.pt)

---

ABB MEASUREMENT & ANALYTICS | DATA SHEET

# RSD100 (Contrac)

Electrical linear actuator

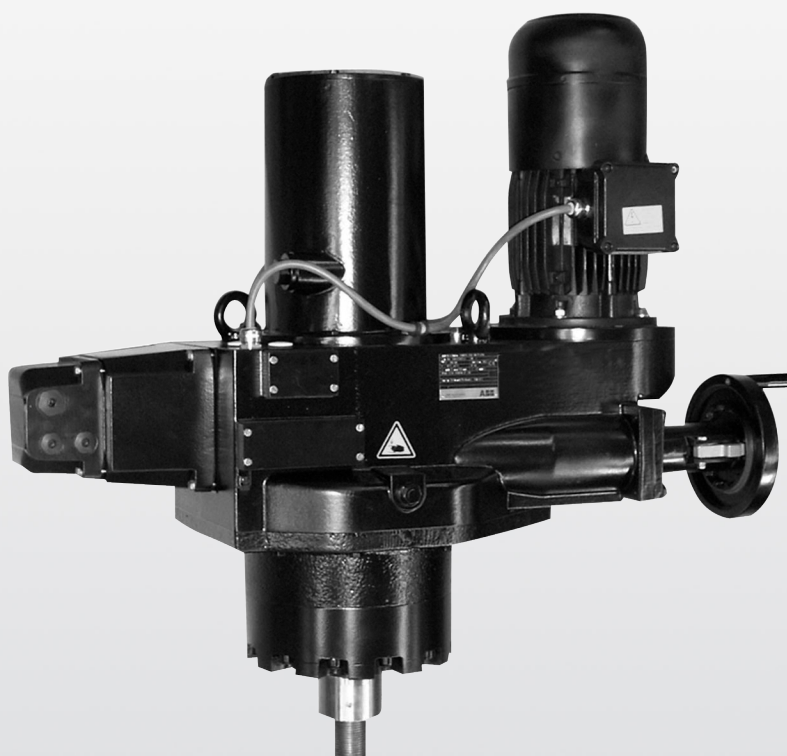

---

For continuous control mode, rated force  
100 kN (22500 lbf)

---

**Electrical actuator for continuous positioning or step control**

---

**Stall-proof without the need for position- or torque-dependent shut-off**

---

**Three-phase asynchronous motor**

---

**Sturdy gear unit with highly efficient design**

---

**Internal rotary-linear conversion**

---

**Handwheel for emergency operation**

---

**Integrated position and temperature sensors**

---

**Signal and power input only via electronic unit in separate field mount housing**

---

**Power supply 115 V AC or 230 V AC via electronic unit only**

## Brief description

Compact actuator for the operation of final control elements with preferably linear movement. The actuator thrust rod transfers the force directly to the final control element. The actuator is controlled using a Contrac electronic unit. This electronic unit serves as the interface between the actuator and the control system.

During continuous positioning, the electronic unit varies the motor torque steplessly until the actuator force and the control valve force are balanced. High response sensitivity and high positioning accuracy with short positioning time ensure an excellent control quality and a long actuator life.

## Operating principles

The actuator continuously responds to a set point signal. The motor is permanently under voltage (operating mode S9 - 100 % stall-proof according to IEC 60034-1 / EN 60034-1) and gently increases or reduces the torque on the electronic unit in proportion to the  $\Delta Y$  signal (the difference between the Y set point and the Y position signal).

The actuator is not subject to temperature derating, i.e., there are no restrictions, even at the maximum permissible ambient temperature. Where a state of balance exists, the actuator force and process force are equivalent and the actuator keeps the final control element in the required position.

The classification of the 'S9 - 100 % overload protected' Contrac actuator in accordance with IEC 60034-1 / EN 60034-1 by far exceeds the requirements for the highest class, 'continuous modulation, class D' in accordance with EN 15714-2.

The Contrac actuator offers extensive process optimization capabilities thanks to its high-precision and highly dynamic operation.

## Linear actuators

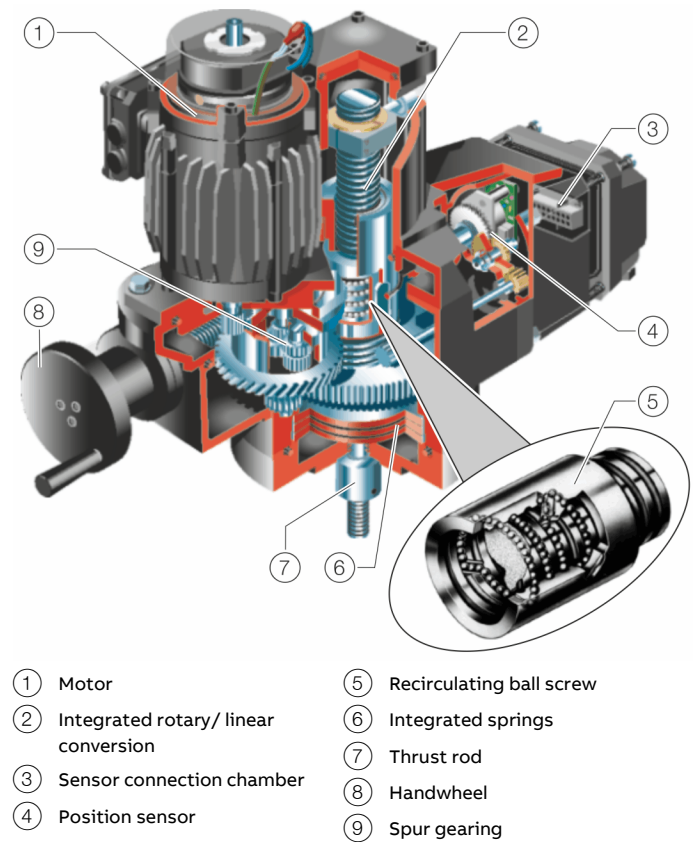

Figure 1: Cross-section of a linear actuator (example)

Linear actuators are available for rated forces from 2 to 100 kN (450 to 22500 lbf) and feature a common design principle.

For the integrated rotary-linear conversion, the motor drives a low-friction recirculating ball screw (located on the thrust rod) via an oil-lubricated spur gear. This moves the thrust rod outwards or inwards, depending on the motor's direction of rotation.

Integrated springs absorb any peak loads which might occur when approaching the end positions for the valve. They also, however, absorb temperature-related alterations to the length of the thrust rod or valve stem (e.g. when mounting the actuator on a superheated steam pipe).

This design principle in conjunction with the 3-phase asynchronous motor serves as the basis for the continuous operation mode of the actuator.

## ... Brief description

### ... Linear actuators

The handwheel offers an optimum level of performance between handwheel forces and rotational speed, owing to the design principle of the differential gearing. Furthermore, the gear train is not interrupted, even though it is possible to adjust the handwheel at any time. This ensures maximum operational reliability. The 3-phase asynchronous motor is equipped with a spring-loaded brake. The brake is energized in automatic mode. In the case of a fault or failure of the supply voltage, the brake will engage via the spring force and lock the control valve in the current position. This ensures reliable 'Fail-Freeze' action. The brake is maintenance-free, regardless of whether the actuator is controlled via analog, bus, or step controller signals.

### Analog signal and power input

For analog control, the set point entry is received from the control system through a 0 to 20 mA or 4 to 20 mA current value. Signal monitoring is possible. Should the signal leave the pre-defined limits, the actuator will perform the set safety procedure (e. g. 'Lock in last position' or 'Drive to safety position').

The position feedback is also given through a 0 to 20 mA or 4 to 20 mA feedback signal. There are 3 digital inputs and 3 digital outputs available in addition to the analog signal. If a digital input is activated, it will take priority over the set point signal (manual mode takes priority over automatic mode).

The following digital input configurations are possible:

Configuration	Digital input 1	Digital input 2	Digital input 3
OFF	No function	No function	No function
Manual intervention	Manual mode / Automatic mode switching	Travel command in OPEN direction	Travel command in CLOSE direction
Rapid traverse	Rapid traverse mode / Automatic mode switching	Rapid traverse travel command in OPEN direction	Rapid traverse travel command in CLOSE direction
Step controller	ON / OFF step controller activation	Step controller pulses in OPEN direction	Step controller pulses in CLOSE direction

The digital output function is freely selectable for each output. The following functions are available:

Function	Description
Ready to operate	Signaling of device status.
Signal end position 0 %	Actuator has reached the 0 % position.
Signal end position 100 %	Actuator has reached the 100 % position.
Signal limit value 1 rising	While the signal level is rising, the actuator has reached the position defined as limit value 1.
Signal limit value 1 falling	While the signal level is falling, the actuator has reached the position defined as limit value 1.
Signal limit value 2 rising	While the signal level is rising, the actuator has reached the position defined as limit value 2.
Signal limit value 2 falling	While the signal level is falling, the actuator has reached the position defined as limit value 2.
Collective failure	Drive function is no longer given. The actuator is no longer available.
Collective alarm	Parameters in the Contrac interface system have adopted values, which make a failure in the near future likely. The actuator remains functional.
Local operation	The actuator is operated via the local control station (ISF)
Rapid traverse + direction	Actuator is moving at rapid traverse speed in + direction (only for 2-motor version).
Rapid traverse control -direction	Actuator is moving at rapid traverse speed in - direction (only for 2-motor version).

### Step controller operation

In the 'step controller' operating mode the incoming control commands are received as pulses at digital inputs 2 and 3 these are upward-integrated into an internal memory. The memory uses these pulses to generate an 'artificial' internal set point which the actuator then follows. This process is as easy on the control valve and actuator operation as the analog control process.

### Rapid traverse mode

The actuator is operated exactly in the same operating mode as in the analog control mode. On activation of digital inputs 2 or 3, the actuator moves at twice the rated operating speed and half the torque in the corresponding direction. Just before the end position is reached, the actuator travel speed is automatically switched back to the set speed, at which the remaining distance is covered.

## Speed

Contrac actuators offer different speed adjustments for both directions, independently of actuator torque or actuator force. Furthermore, a speed characteristics curve can be set with three different speed values for each direction. The actuator speed is steplessly adapted to the rate of change in speed of the set point value. This ensures a highly dynamic and extremely precise control process. In order to preserve the control valve, the actuator speed is automatically reduced before the end position is reached.

## Torque/Force

The torque and actuator force setting options are comparable to the speed setting options. 50 %, 75 % and 100 % of the rated output value can be selected. The electronic unit alters the motor actuation according to the selected value.

## Set point monitoring

The set point can be monitored for compliance with the adjustable limit values. Should the set point exceed the upper limit value or fall below the lower limit value, the actuator will perform the previously defined safety action. 'Lock in current Position' or 'Move to pre-defined safety position' are available as safety actions.

## Ambient conditions

### Temperature

Different temperature versions are available, dependent on the actuator type.

The power-up period is not subject to derating, i.e. even at the maximum permissible ambient temperature, the actuator ensures maximum control precision and dynamics during a power-up period of 100 %.

### Corrosion protection

Contrac actuators and electronic units have been designed for operation in extreme ambient conditions. They satisfy the requirements of atmospheric corrosivity category C5-I (highly polluted industrial atmospheres) for protection against external corrosion in accordance with DIN EN 15714 (Electric actuators for industrial valves – Basic requirements), and EN ISO 12944-2:1998 (Paints and varnishes. Corrosion protection of steel structures by protective paint systems. Classification of environments).

Electronic cabinet modules satisfy the requirements of category C1 (low pollution) as per EN ISO 12944-2:1998 (Paints and varnishes. Corrosion protection of steel structures by protective paint systems. Classification of environments).

### Maintenance interval

Contrac actuators and electronic units exceed the service life requirements for the highest class D, 'continuous modulation', as per DIN EN 15714 (Electric actuators for industrial valves – Basic requirements). The actuators remain maintenance-free for up to 10 years under 'normal' load.

### Expected service life of the device

With proper use and consideration of relevant environmental conditions, the service life of the Contrac actuators and electronic units can reach approx. 10 years.

Regular maintenance work and / or proper repairs by ABB Service, along with the use of ABB spare parts, can extend the service life of the Contrac actuators and electronic units.

---

## Communication

The PROFIBUS DP®, PROFIBUS DP®/V1 or HART® communication protocols are available for digital communication.

### PROFIBUS®

PROFIBUS DP® is an international, open field bus protocol which has been standardized in the field bus standard EN 50170. On a cyclic basis, the master reads the input information from the slaves and writes the output information to the slaves. In addition to this cyclic data transfer of the process representation (e. g. setpoint and actual value), Profibus DP also provides powerful functions for diagnostics and commissioning. PROFIBUS DP/V1 additionally offers the acyclic transfer of data for the configuration of slaves, for example. Data traffic is monitored through the monitoring functions on the master and slave sides. In addition to PROFIBUS® data transfer, ABB Contrac actuators provide two configurable binary outputs to for example signal that the end position has been reached. The two configurable digital outputs can be used independently of the bus communication.

### HART®

Contrac actuators also offer the option of using the HART® communication protocol for configuration and parameterization while operation is in progress. HART®-FSK communication enables simultaneous analog set point transmission and digital communication without additional installation. The HART signal is modulated on to the 4 to 20 mA analog set point signal. The HART® protocol works with Frequency Shift Keying (FSK) technology, based on the Bell 202 communication standard.

### FDI – Field Device Integration

The Device Type Driver for Contrac actuators is based on FDI technology and can either be integrated in a control system or loaded onto a PC with the ABB Ability™ Field Information Manager (FIM).

This allows you to work with the same user interface in the commissioning phase, during operation, and for service tasks involving monitoring the device, parameterization, and reading out data.

### DTM

The DTM (Device Type Manager) for Contrac actuators is based on FDT / DTM technology (FDT 1.2 / 1.2.1) and can either be integrated into a control system or loaded on a PC with an FDT framework application. This allows you to work with the same user interface in the commissioning phase, during operation, and for servicing tasks, involving monitoring the device, setting parameters, and reading out data. Communication is based on HART® protocol or PROFIBUS® communication. Reading out data from the device has no effect on the operation in progress. Newly set parameters are saved in the non-volatile memory directly upon download to the device, and become active immediately.

### EDD

Similar to DTM, the EDD (Electronic Device Description) provides the option of configuration and parameterization of the device through HART® communication by using a handheld terminal or an EDD integrated in the system.

## Specification

### Control actuator

	<b>DS_RSD100_EN_C</b>
Operating mode	S9; stall-proof as per IEC 60034-1 / EN 60034-1
IP rating	IP 66
Humidity	≤ 95 % annual average; condensation not permitted
Ambient temperature	-10 to 65 °C (15 to 150 °F) -30 to 50 °C (-20 to 130 °F)
Transport and storage temperature	-40 to 70 °C (-40 to 160 °F)
Long-term storage temperature	-30 to 40 °C (-22 to 104 °F)
Mounting position	IMV1; IMV3; IMB5; preferably IMV1 acc. to IEC 60034-7 / EN 60034-7
Coating	2-layer component epoxy (RAL 9005, black)
Anti-condensation heater	Motor winding: directly from electronic unit. Signal space: separate heating resistor; separate power supply or power feed from Contrac electronic unit
Electrical connection	Plug connection with crimp snap-in contacts or screw terminals Connection cable for electronic unit – actuator available as an option (see ordering information for electronic unit)
Power supply for motor and sensors	Via Contrac electronic unit only

	<b>RSD100-1.5</b>	<b>RSD100-10.0</b>
Rated force	100 kN (22500 lbf) (adjustable to 0.5 / 0.75 or 1x rated force)	
Starting force	1.2 × rated force (break-away torque in end positions for short time 2 × rated force)	
Rated operating speed, adjustable	0.1 to 1.5 mm/s (254 to 17 s/in)	0.1 to 10.0 mm/s (254 to 2.5 s/in)
Stroke	min.: 0 to 25 mm (0 to 0.98 in) / max. 0 to 150 mm (0 to 5.9 in) or min.: 0 to 60 mm (0 to 2.36 in) / max. 0 to 300 mm (0 to 11.8 in)	
Weight (120 mm stroke)	Approx. 215 kg (474 lb)	Approx. 242 kg (534 lb)
Weight (300 mm stroke)	Approx. 275 kg (606 lb)	Approx. 273 kg (602 lb)
Associated electronic unit	For field mounting: EBN853 For rack installation: EBS852	For field mounting: EBN861 For rack installation: EBS862
Motor	MC 90 BA	MC 112 BA
Sensors	Position and temperature sensor always available	

## ... Specification

### Electronic unit

#### Note

Detailed information on separate electronic units can be found in the corresponding data sheets.

#### Power supply

<b>RSD100</b>				
Supply voltage	115 V AC (94 to 130 V) or 230 V AC (190 to 260 V); 47.5 to 63 Hz; single-phase			
Current consumption at the electronic unit [A] (AC 115 V / AC 230 V)	RSD100-1.5	$I_{\max}$ at 115 V: 5.0 A	$I_{\max}$ at 230 V: 2.5 A	$I_{\text{pos}}$ (115 + 230 V): approx. 40 to 50 % of $I_{\max}$
	RSD100-10.0	-	$I_{\max}$ at 230 V: 12.5 A	$I_{\text{pos}}$ (230 V): approx. 40 to 50 % of $I_{\max}$
External fuse RSD100-1.5	16 A; time-lag			
External fuse RSD100-10.0	Safety fuse 35 A (Lindner) + thermal circuit breaker 16 A (ETA)			

#### Communication

<b>Conventional communication</b>	
Analog input	0 / 4 to 20 mA; internal load: 300 $\Omega$
Analog output	0 / 4 to 20 mA, electrically isolated, max. load 500 $\Omega$
3 digital inputs, 1 to 3	Digital 0: -3 to 5 V or open, electrically isolated
	Digital 1: 12 to 35 V, electrically isolated
3 digital outputs, 1 to 3	Potential-free relay contact, max. 60 V, 150 mA
Digital communication	RS232 for commissioning and service, with optional FSK / HART® or PROFIBUS DP®
Default settings	see Table <b>Conventional communication</b> on page 10.
Voltage output $U_V$	24 V, 15 mA, electrically isolated, for scanning external contacts, or similar applications
Connection for transmitter (optional)	Supply for two-wire transmitter with activated process controller in Contrac
Individual settings	See data sheet 'DS/CONTRAC/SETTING' or available upon request.

<b>PROFIBUS DP® Communication</b>	
PNO ID no.	0×9655 Actuators with DP/V0 communication (cyclic data traffic) 0×09EC Actuators with DP/V1 communication (cyclic and acyclic data traffic)
Communication protocol	PROFIBUS PA® Profile V3.0 Class B in accordance with IEC 50170 / EN 50170 (DIN 19245)
Bus cable	Twisted, shielded copper wire acc. to IEC 50170 / EN 50170
Interface	EIA-485 (RS485) acc. to IEC 50170 / EN 50170
Permissible baud rates	93.75 Kbit/s 187.5 Kbit/s 500 Kbit/s 1500 Kbit/s Automatic baud rate detection
Bus address	0 to 126, default address 126 Set Slave Address service is supported
Bus termination	Connectable active bus termination. Power supply from electronic unit
Block types	1 analog input function block 1 transducer block 1 physical block
Failsafe	Failsafe function is supported. Configurable function for downtime of bus communication <ul style="list-style-type: none"> <li>• Lock in last position</li> <li>• Drive to safety position</li> <li>• Adjust with last effective set point</li> </ul> Adjustable time delay
Modules for cyclic communication	8 standards-compliant modules and 3 manufacturer-specific modules are available.* SP (Short) SP (Long) RCAS_IN+RCAS_OUT SP+READBACK+POS_D SP+CHECKBACK SP+READBACK+POS_D+CHECKBACK RCAS_IN+RCAS_OUT+CHECKBACK SP+RCAS_IN+READBACK+RCAS_OUT+POS_D+CHECKBACK STANDARD SP+RB+MESSEING SP+RB+ENL_DIAG
Acyclic communication	Full parameterization and configurability via Master Class 2 and DTM
Default settings	see Table <b>PROFIBUS DP® communication</b> on page 10.
Digital outputs 1 and 2	In addition to the PROFIBUS®-communication, there are 2 digital outputs. Potential-free relay contact, max. 60 V, 150 mA Default setting: Digital output 1 End position signal 0 % Digital output 2 End position signal 100 %
Individual settings	See data sheet 'DS/CONTRAC/SETTING' or available upon request.

\* A full description of communication modules can be found in parameterization and configuration instructions 45/68-10

## ... Specification

### ... Electronic unit

#### Delivery state

The standard delivery scope includes metric cable entry threads with IP66 seal plugs. Optional NPT and PG adapters are available. The individual actuator configuration may vary from the standard setup above. This information can be displayed via the user interface. Unless otherwise specified by the user, the electronic units are delivered with the following standard configuration:

#### Conventional communication

Parameter	Setting
Function selection	Positioner, parameter: set point
Set point function	Analog set point
Set point range	4 to 20 mA
Set point characteristic	Linear; set point = position value
Actual value range	4 to 20 mA
Nominal torque / rated force in $\pm$ direction	100 %
Automatic speed in $\pm$ direction:	100 %
Action in 0 % / 100 % end position	Keep leak-tight with nominal torque / rated force
Digital inputs	Digital input 1 Manual / Automatic switching, Digital input 2 / 3 Travel command $\pm$
Digital outputs	Digital output 1 ready for operation / error message, Digital output 2 / 3 end position signaling 0 % / 100 %
Brake Away Function	Deactivated
Shut-off function	Deactivated
Positioning loop monitoring	Deactivated
Set point monitoring	Deactivated
Alarm Type	Deactivated
Action after restoration of power	Switch to Automatic
Working range of actuator	Not set

#### PROFIBUS DP® communication

Parameter	Setting
Function selection	Positioner, parameter: set point
Set point function	Digital
Set point range	4 to 20 mA
Set point characteristic	Linear; set point = position value
Actual value range	Digital
Nominal torque / rated force in $\pm$ direction	100 %
Automatic speed in $\pm$ direction:	100 %
Action in 0 % / 100 % end position	Keep leak-tight with nominal torque / rated force
Digital outputs	Digital output 1 / 2 end position signal 0 % / 100 %
Brake Away Function	Deactivated
Shut-off function	Deactivated
Positioning loop monitoring	Deactivated
Communication monitoring	PROFIBUS DP® / V0: Activated Lock in last position PROFIBUS DP® / V1: Activated After delay time has elapsed (standard configuration 5 s) Lock in last position
Alarm Type	Deactivated
Action after restoration of power	Switch to Automatic
Working range of actuator	Not set

## Electrical connections

### Wire cross-sectional areas

#### Control actuator

##### Crimp pins

Motor / brake / heater	max. 1.5 mm <sup>2</sup> (16 AWG)
Signals	max. 0.5 mm <sup>2</sup> (20 AWG)
Contact surface	Gold-plated

##### Screw terminals (optional)

Motor / brake / heater	max. 2.5 mm <sup>2</sup> (14 AWG)
Signals	max. 2.5 mm <sup>2</sup> (14 AWG)
Contact surface	Motor / brake / signals: Gold-plated Heater: Silver-plated

#### Electronic unit

##### EBN853 – Screw terminals

Motor/brake	fixed: 1.5 to 6 mm <sup>2</sup> (16 to 10 AWG)
	flexible: 0.2 to 4 mm <sup>2</sup> (24 to 12 AWG)
Mains	fixed: 1.5 to 6 mm <sup>2</sup> (16 to 10 AWG)
	flexible: 0.5 to 4 mm <sup>2</sup> (20 to 12 AWG)
Signals	fixed: 0.5 to 4 mm <sup>2</sup> (20 to 12 AWG)
	flexible: 0.5 to 2.5 mm <sup>2</sup> (20 to 14 AWG)

##### EBN861 – Screw terminals

Motor/brake	fixed: 1.5 to 6 mm <sup>2</sup> (16 to 10 AWG)
	flexible: 1.5 to 4 mm <sup>2</sup> (16 to 12 AWG)
Mains	fixed: 0.5 to 6 mm <sup>2</sup> (20 to 10 AWG)
	flexible: 0.5 to 4 mm <sup>2</sup> (20 to 12 AWG)
Signals	fixed: 0.5 to 4 mm <sup>2</sup> (20 to 12 AWG)
	flexible: 0.5 to 2.5 mm <sup>2</sup> (20 to 14 AWG)

##### EBS852 – Clamping connection

Suited for cable Ø Terminals for conductor cross-section

Mains cable	13 mm (0.51 in)	max. 4 mm <sup>2</sup> (12 AWG)
Signal cable (DCS)	8 mm (0.31 in)	max. 1.5 mm <sup>2</sup> (16 AWG)
Transmitter (option)	8 mm (0.31 in)	max. 1.5 mm <sup>2</sup> (16 AWG)
Motor cable	13 mm (0.51 in)	max. 4 mm <sup>2</sup> (12 AWG)
Sensor cable	8 mm (0.31 in)	max. 1.5 mm <sup>2</sup> (16 AWG)

##### EBS862 – Clamping connection

Terminals for conductor cross-section

Mains cable	max. 6 mm <sup>2</sup> (10 AWG)
Signal cable (DCS)	max. 4 mm <sup>2</sup> (12 AWG)
Transmitter (option)	max. 4 mm <sup>2</sup> (12 AWG)
Motor cable	max. 6 mm <sup>2</sup> (10 AWG)
Sensor cable	max. 4 mm <sup>2</sup> (12 AWG)

## Cable glands

The actuators and electronic units are supplied without cable glands. Suited cable glands must be installed on site.

##### Tap holes for cable glands

	metric	optional adapters for*	
Signals	M20 × 1.5 (2 ×)	PG 16 (2 ×)	NPT ½ in (2 ×)
Motor	M25 × 1.5 (1 ×)	PG 21 (1 ×)	NPT ¾ in (1 ×)

\* Adapter for PG or NPT thread must be ordered separately

## Selection of suited connection cables

Please observe the following information when selecting cables:

- Use shielded cables for the motor/brake cable, the sensor cable, and the signal cable to the control system/controller.
- Connect the shielding of the motor/brake cable and the sensor cable on both sides (to the actuator and to the Contrac electronic unit).

## ... Electrical connections

### Electronic unit EBS853 (Contrac) / EBS861 (Contrac)

Analog / Digital

**Note**

The electrical connection is provided by a universal plug on the actuator and the screw terminals on the electronic unit.

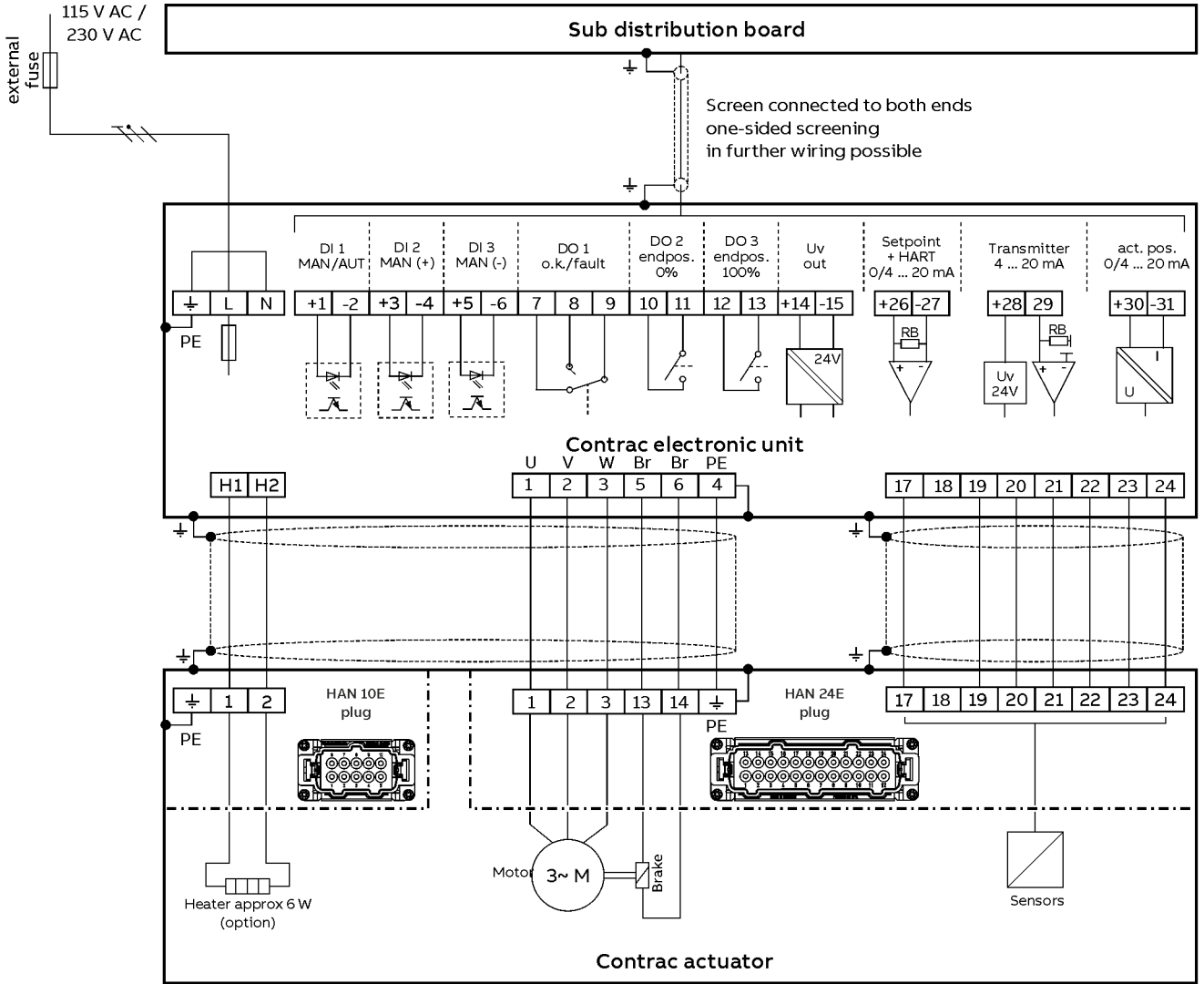

BE = digital input  
 BA = digital output

Figure 2: Control via analog input 0/4 to 20 mA, HART® communication or binary inputs

**PROFIBUS DP®**

**Note**

The electrical connection is provided by a universal plug on the actuator and the screw terminals on the electronic unit.

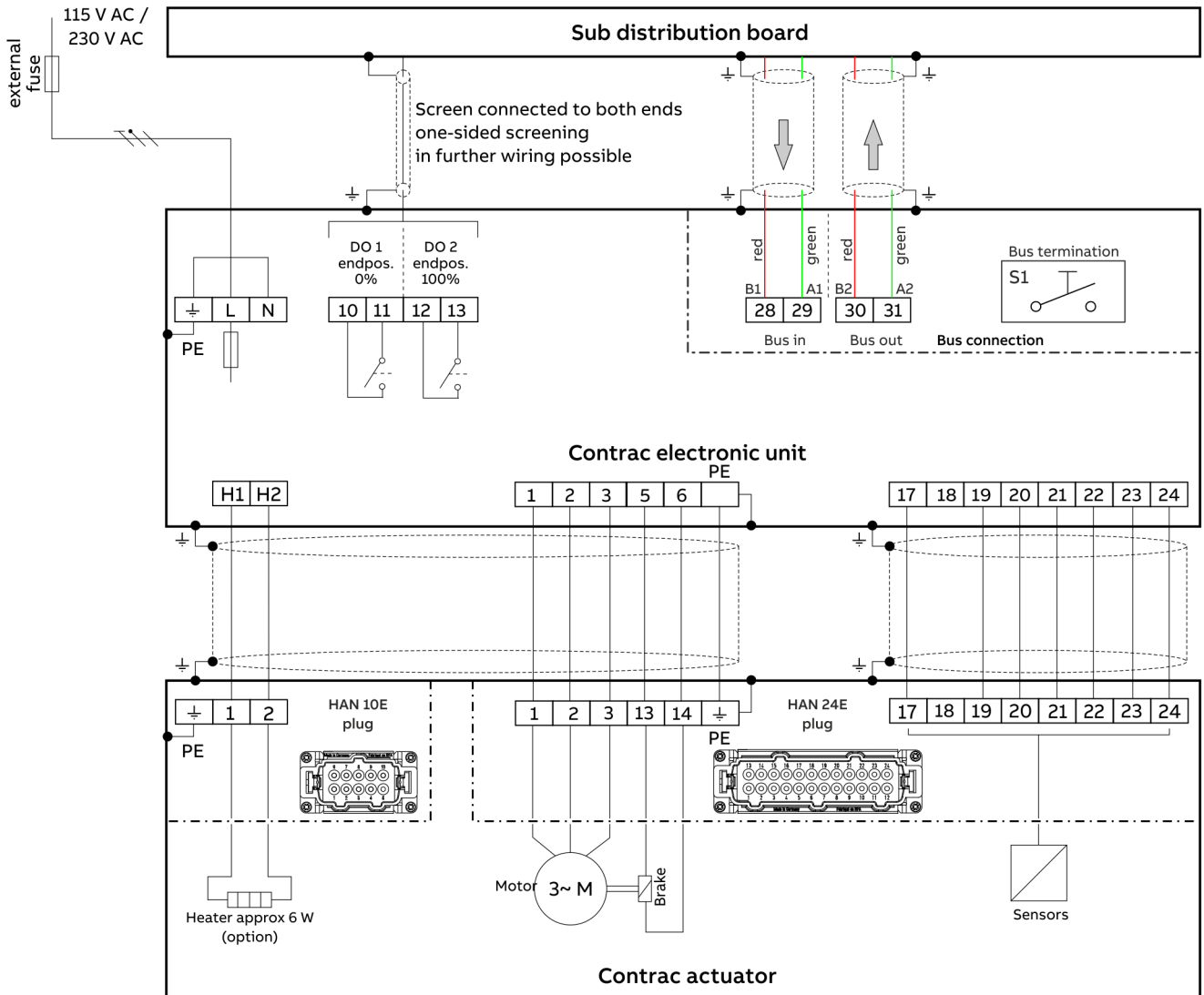

BA = digital output

Figure 3: Control via fieldbus PROFIBUS DP®

## ... Electrical connections

### Electronic Unit EBN852 (Contrac)

#### Analog / Digital

#### Note

- The electrical connection is provided by a universal plug on the actuator and the screw terminals on the electronic unit.
- If you are using a separate heat supply, the heater must be protected with a 2 to 6 A medium time-lag fuse (e.g. NEOZED D01 E14).

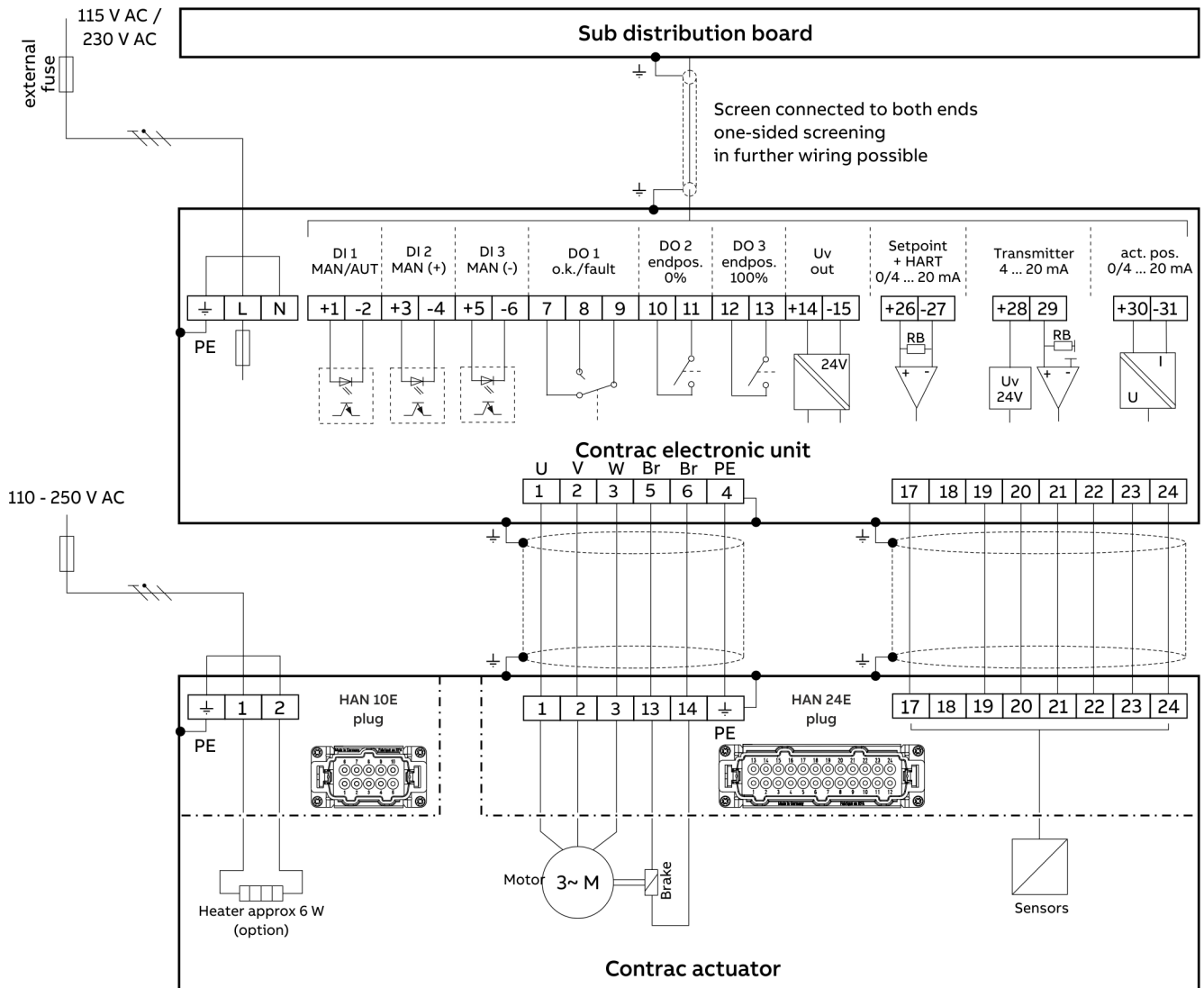

BE = digital input  
 BA = digital output

Figure 4: Control via analog input 0/4 to 20 mA, HART® communication or digital inputs

### Electronic Unit EBN862 (Contrac)

Analog / Digital

**Note**

The electrical connection is provided by a universal plug on the actuator and the screw terminals on the electronic unit.

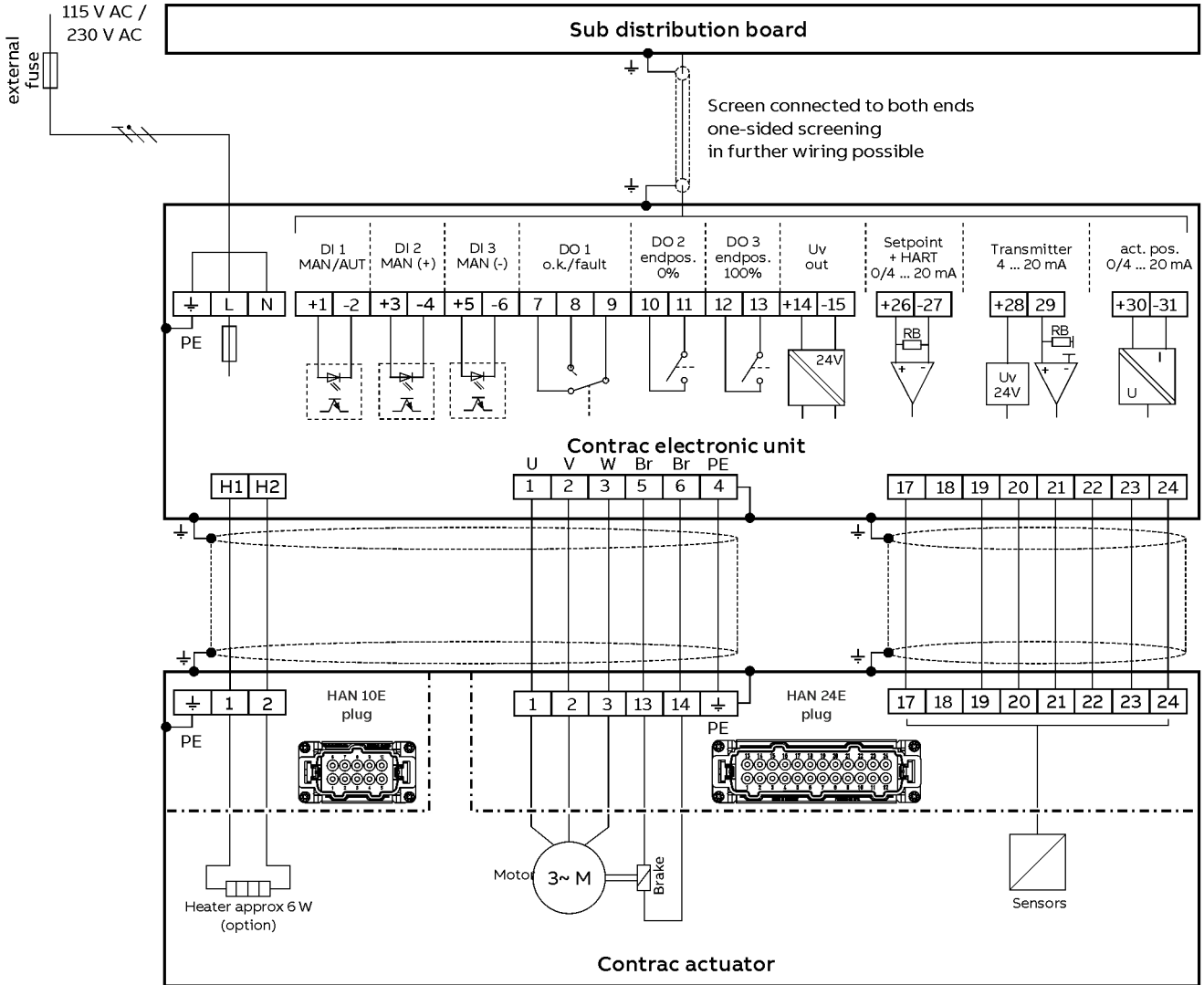

BE = digital input  
 BA = digital output

Figure 5: Control via analog input 0/4 to 20 mA, HART® communication or binary inputs



## Ordering Information

### RSD100

	V68662	XX	XX	XXX	XXX
<b>Basic model</b>					
RSD100 Linear Actuator, rated force 100 kN (22500 lbs) (adjustable to 50 % / 75 % / 100 %)					
<b>Rated Stroke</b>					
150 mm (5.9 in)		14			
300 mm (11.8 in)		16			
<b>Rated Speed</b>					
1.5 mm/s (17.0 s/in) (adjustable to 1.5 to 0.1 mm/s), only for RSD100-1,5			16		
10.0 mm/s (2.5 s/in) (adjustable to 10.0 to 0.1 mm/s), only for RSD100-10,0			17		
<b>Electrical Connection</b>					
Plug (24-pole) complete, crimped				277	
Plug (24-pole) complete, terminals				278	
Plug bottom part covered				279*	
<b>Ambient Temperature Range</b>					
-10 to 65 °C (15 to 150 °F)					344
-30 to 50 °C (-22 to 125 °F)					341

\*) Female plug with cables to be ordered with electronic unit





## Trademarks

HART is a registered trademark of FieldComm Group, Austin, Texas, USA

PROFIBUS and PROFIBUS DP are registered trademarks of PROFIBUS & PROFINET International (PI)

Sales



Service



---

## **ABB Measurement & Analytics**

For your local ABB contact, visit:

**[www.abb.com/contacts](http://www.abb.com/contacts)**

For more product information, visit:

**[www.abb.com/actuators](http://www.abb.com/actuators)**











---

We reserve the right to make technical changes or modify the contents of this document without prior notice. With regard to purchase orders, the agreed particulars shall prevail. ABB does not accept any responsibility whatsoever for potential errors or possible lack of information in this document.

We reserve all rights in this document and in the subject matter and illustrations contained therein. Any reproduction, disclosure to third parties or utilization of its contents – in whole or in parts – is forbidden without prior written consent of ABB.



## Our offering:

	Actuators and Positioners		Analytical Instruments
	Device Management, Fieldbus and Wireless		Flow Measurement
	Force Measurement		Level Measurement
	Natural Gas Measurement		Pressure Measurement
	Recorders and Controllers		Temperature Measurement

---

## HMI – Automação e Instrumentação, Lda.

---

Travessa da Indústria, nº 111  
4780-573 Santo Tirso  
PORTUGAL

Tel. +351 252 850 501  
Fax. +351 300 013 487

Web: [www.hmi.pt](http://www.hmi.pt)

Email: [hmi@hmi.pt](mailto:hmi@hmi.pt)