



hmi

high-accuracy
measurement
instruments

FICHA TÉCNICA DE PRODUTO

PRODUCT DATASHEET

HMI – Automação e Instrumentação, Lda.

Travessa da Indústria, nº 111
4780-573 Santo Tirso
PORTUGAL

Tel. +351 252 850 501
Fax. +351 300 013 487

Web: www.hmi.pt

Email: hmi@hmi.pt

KCAP300

RF Capacitance Level Switch

KCAP300 with KSHIELD™
sensing probes and electronics

K-TEK Level products



Introduction

This operating instruction manual provides the following information:

- Specifications—see page 6
- Installation instructions—see page 7
- Operating and setup—see page 9
- Troubleshooting—see page 16

TABLE OF CONTENTS

1. INTRODUCTION	5
1.1 Description	5
1.2 Basic Theory of Operation	5
1.3 Features	5
1.4 Options	5
2. SPECIFICATIONS	6
2.1 Environmental	6
2.2 Electrical	6
2.3 Dimensional	6
3. INSTALLATION	7
3.1 General	7
3.2 Recommendation	8
3.3 Caution	8
4. OPERATION and SETUP	9
4.1 Detailed Theory of Operation	9
4.2 Accessing Setup Adjustments	12
4.3 Default Settings / Reset	12
4.4 Setpoint Calibration (One Touch Calibration)	13
4.5 Fail Safe / Relay Operation	13
4.6 Sensitivity / Hysteresis	14
4.7 Time Delay	15
5. TROUBLESHOOTING	16
5.1 "Out-of-Calibration" Indication	16
5.2 Symptoms and Remedies	17
5.3 Warranty	19
5.4 Company Information	19

1. INTRODUCTION

1.1 Description

The KCAP300 is a RF Capacitance switch designed for single point level detection in both solids and liquids. Its KSHIELD technology, coupled with the three element probe design, provides reliable response in cases where buildup may occur. The LED indicators of the KCAP300's modular electronics allow for simple calibration, and status detection. Its rugged construction allows it to withstand the rigors of just about any industrial environment.

1.2 Basic Theory of Operation

Every material has a relative permittivity or dielectric constant. A basic capacitance switch uses this dielectric constant to complete a capacitance circuit between a sensor and a reference. The presence of a material creates a shift in the received capacitance causing the switch to activate. While these basic capacitance style switches are useful, the presence of buildup on the probe can cause the unit to fail.

The KSHIELD technology of the KCAP300, along with the three-element probe design void out the effects of buildup. By utilizing a second capacitance circuit the buildup can be compensated for in the reference capacitance and point level detection can be maintained.

1.3 Features

- Liquids and Bulk Solids
- KSHIELD™ Sensing Probes and Single Setpoint Electronics that Provide Immunity to Buildup
- Integral and Remote Electronics
- Easy Set Up Via External Magnet or Pushbuttons
- Housing with Glass Viewing Cover
- Wide Variety of Sensing Probes to (450°F / 800 psig)
- Single Point Detection
- Single Touch Calibration with Out-of-Cal Light
- Element Sensitivity Down to 0.5 pF

1.4 Options

- 316L SS Enclosure
- External "Alarm" Indicating Lamp
- Tip Extended Extensions to 60 in / 1524 mm
- Pipe Extensions to 240 in / 6096 mm
- Industry Standard Bulk Solids Mounting Plate
- Process Connections: 3/4"NPT, 1 1/4"NPT, and Custom Flanges

2. SPECIFICATIONS

2.1 Environmental

Housing type	Explosion Proof, Powder Coated Cast Aluminum Standard
Temperature	Electronics: -40 to 170° F / -40 to 77°C
Dielectric	1.4 or greater
Remote Mounting	Max. length of 200 ft. from sensing probe to the remote electronics

2.2 Electrical

Input Power	95 - 130 VAC, 50-60 Hz, 2 Watts; 180 - 260 VAC, 50 - 60 Hz; 24 VDC +/- 5%;
Relay Contact Rating	1x DPDT Resistive: 10 Amp, 250 VAC; 10 Amp, 30 VDC Inductive: 1/5 HP 125, 250 VAC
Static Protection	Peak Surge Current: 800 amps Clamp Voltage: 745 volts
Cable Entry	2x 3/4" NPT

2.3 Dimensional

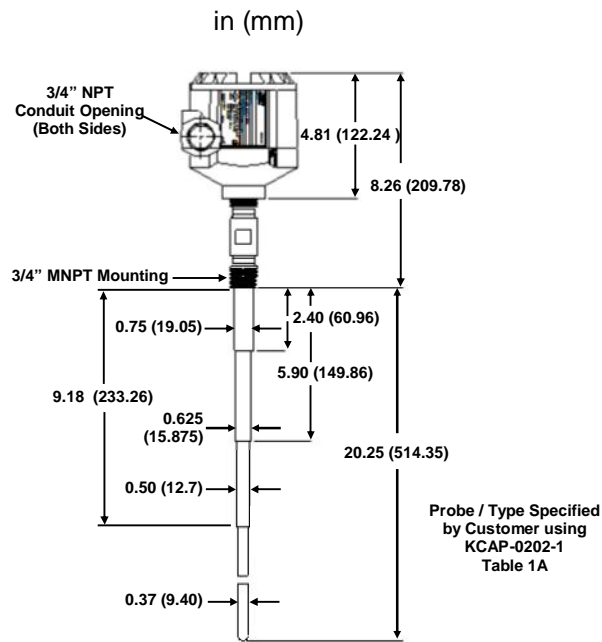

Figure 1

3. INSTALLATION

3.1 General

After unpacking the unit, inspect it for any evidence of shipping damage. Any claims for damage due to shipping must be filed with the carrier who handled the package(s).

- Select a mounting location for the switch and the sensor probe. Your unit may be the integral mounting option or the remote mounting option. The integral mounting unit consists of a single enclosure that includes the electronic module and the sensor probe. The remote mounting unit consists of two enclosures, one containing the electronic module and the other containing the sensor probe.
- Be sure that there is sufficient clearance around the mounting position to allow for the turning radius of the switch or remote sensor enclosure as the unit is screwed into place. Allow sufficient room above the vessel entry to be able to insert the probe into the opening of the vessel.
- The thread size of the vessel coupling should be 3/4" NPT for most probes. Certain special applications may utilize couplings of different sizes.
- The information included on the label should be visible. If necessary to make it readable, clean the label using a cloth soaked with either water or isopropyl alcohol.

CAUTION: When making the opening in the vessel, observe all safety requirements of the area in which the work is being done. Be especially careful when working with pressure vessels.

The Model KCAP300 unit may not work properly if:

- The material dielectric constant is less than 1.7.
- There is a conductive bridge between probe and vessel wall,
- The unit does not have a good ground connection.
- Probe insulation is damaged.
- Probe is located near a material fill line.
- Probe is mounted improperly.

The Model KCAP300 unit may be damaged if:

- Temperature in the Model KCAP300 housing exceeds appropriate limits.
- The process temperature exceeds probe's operating limits.
- The electronics module is subjected to excessive vibration or shock.
- Vessel pressure exceeds process operating pressure rating of probe.

CAUTION: If any of the above statements apply to your application, do not install the switch until you contact your local representative or the ABB factory for further instructions.

3.2 Recommendations

Integral units

- Install the switch into the vessel coupling and connect conduit between the switch and the supply source as required.
- Be sure the conduit is suitable for the environment in which the units are to be used.

Remote units

- Install the remote sensor probe into the vessel coupling. Select a suitable location for the instrument housing that allows convenient access for calibration.
- Connect conduit between the remote sensor housing and the instrument housing.
- Connect the RG62 type coaxial cable assembly supplied with the unit from the remote probe to the instrument input.
- Connect conduit between the switch and the supply source as required. Be sure the conduit is suitable for the environment in which the units are to be used.

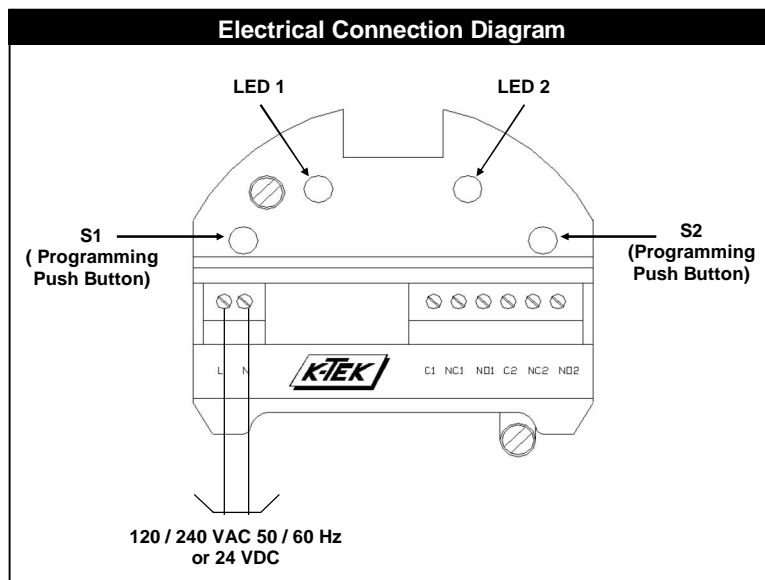

Due to the extremely wide range of control and/or alarm applications in which the unit may be used, it is not possible to show all conceivable wiring diagrams. Consult your representative or ABB factory if further assistance is needed.

3.3 CAUTION

Be sure that all wiring and conduit conforms to the requirements of the National Electrical Code and any enforcing authorities or agencies having jurisdiction over the installation. Be sure that any special conditions, such as areas having explosion hazards, are given full consideration.

- After installing and wiring, it is necessary to calibrate the unit to the particular vessel and material that will be measured, using the standard calibration procedure.
- The KCAP300 has a Reset capability to restore the factory default values, which can be done by placing the magnet on the "X" position for 30 seconds. The current level of the tank is chosen as the new set point. See RESET in Section 4.3 for details of this procedure.
- Both liquid and dry products have dielectric values. The KCAP300 RF Switch is designed to monitor levels of liquid and dry products with a stable dielectric constant greater than 1.4.

4. OPERATION and SETUP

4.1 Detailed Theory of Operation

The KCAP300 works on the same principal as any other capacitance type switch. The switching operation takes place when a sensed capacitance varies in comparison to a reference capacitance set by the user. In simple capacitance switches, a buildup of material between the sensor and the ground reference can cause the switch to malfunction either not switching or resetting as it should.

To compensate for potential buildup on the sensor, the KCAP300 is equipped with KSHIELD™ software and a three element probe assembly. The center element of the three element probe acts as a shield for the sensor, both mechanically and electronically. Establishing a second capacitance circuit between the shield and the ground reference allows the switch to vary its reference capacitance and compensate for the buildup on the probe. In essence, the KCAP300 is not comparing the sensed capacitance to a set reference capacitance but comparing the sensed capacitance to a floating baseline capacitance.

Figure 4.1.1

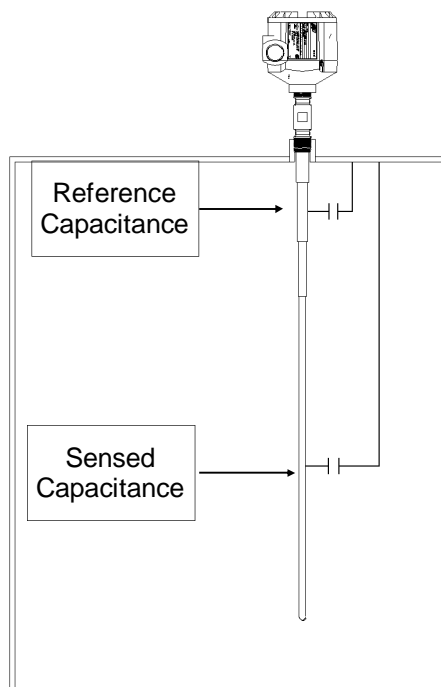

During normal operation, several factors will be taken into account which will affect the action of the relays within the KCAP300. (For this explanation, we will have the Fail Safe set to Low.) When the KCAP300 is calibrated the software establishes a baseline capacitance for the set-point. If the sensed capacitance were to rise or fall across this baseline the set-point would be reached. If the relays were to act at this point, the switch would operate erratically. (Figure 4.1.2)

Figure 4.1.2

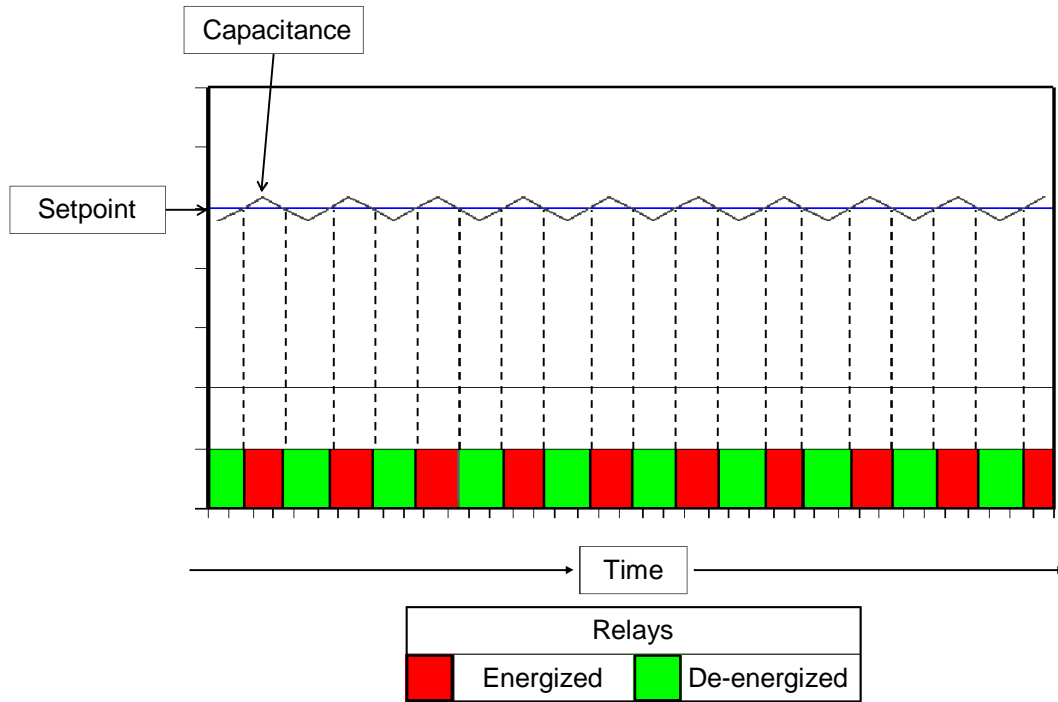

For this reason, a Sensitivity or Hysteresis adjustment has been incorporated in the software. Sensitivity adds a capacitance factor to the baseline. In order for the relays to energize, the sensed capacitance must not only surpass the baseline it must surpass the added capacitance. The set-point plus the sensitivity becomes the switch point. For the relays to de-energize, the sensed capacitance must decrease to less than 1/3 of the sensitivity plus the baseline. (Figure 4.1.3)

Figure 4.1.3

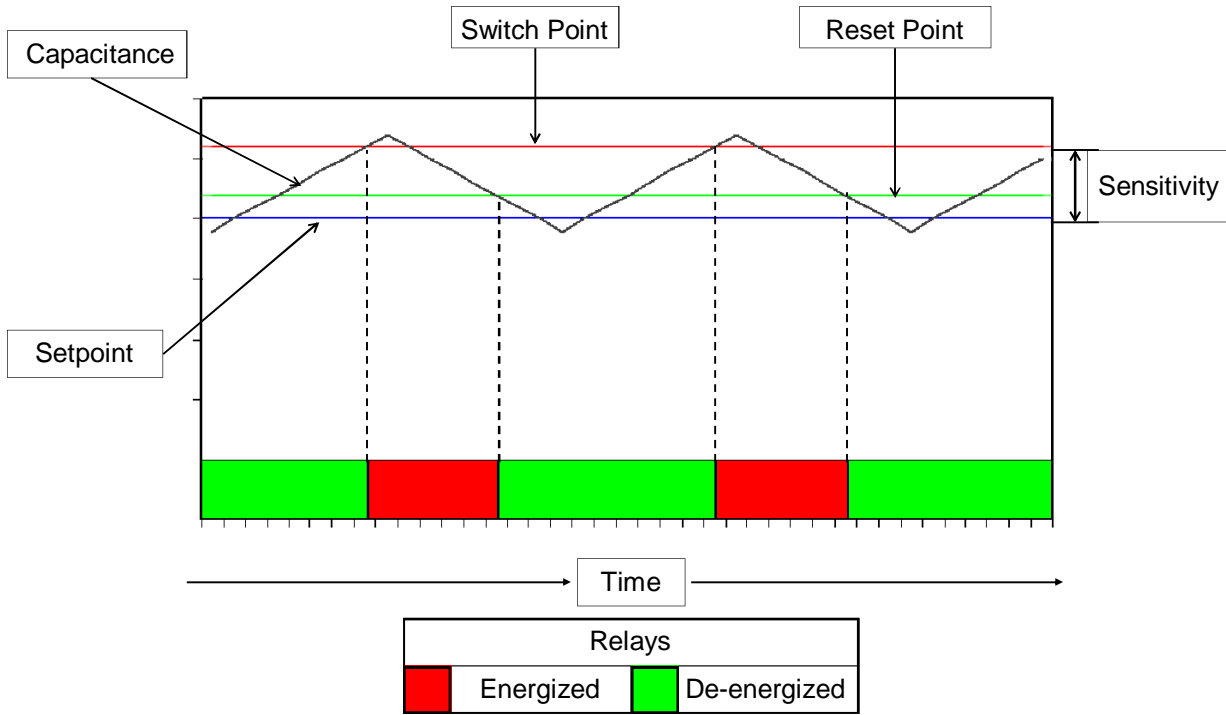

Along with the Sensitivity a Time Delay adjustment has been incorporated. The Time Delay will allow the relays to wait a specified time after the switch point has been reached before energizing. This added Time Delay will affect the relay operation on both energize and de-energize cycles. (Figure4.1.4)

Figure 4.1.4

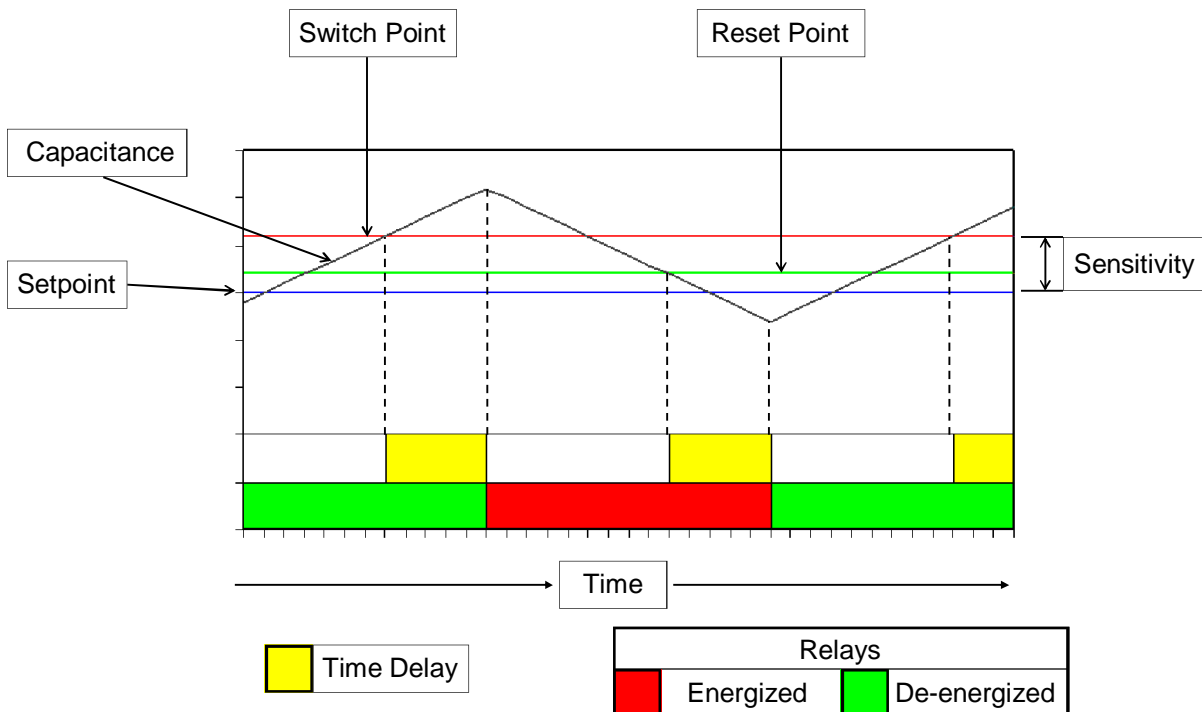

4.2 Accessing Setup Adjustments

Calibration and Setup of the KCAP300 may be achieved using a magnet positioned on the housing or by means of the pushbuttons on the module. In the following operations, pushbuttons will correspond to magnet positions as follows:

- X position = S1 and S2 buttons simultaneously
- S1 position = S1 button only
- S2 position = S2 button only

During normal operation, LED1 will light either red or green based on the settings of the switch.

4.3 Default Settings / Reset

Each KCAP300 will be supplied with the following default settings:

- Time Delay = Instant
- Sensitivity/Hysteresis = Medium
- Fail Safe Mode = Low Level
- Set Point = Current Level

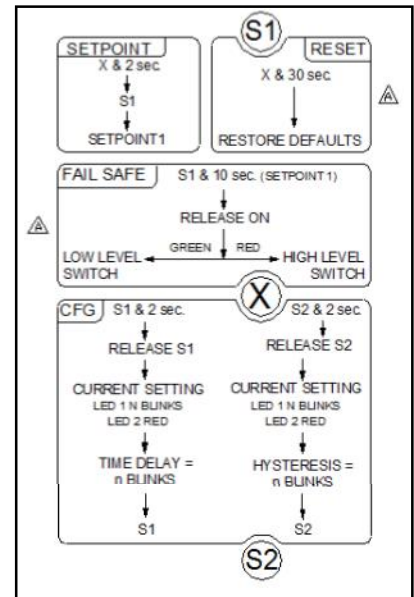

To restore the default settings, place the magnet on the X position for 30 seconds. The following sequence of lights will be observed (Table 1):

TABLE 1		
OPERATION	LED 1	LED 2
NORMAL	GREEN or RED	OFF
X = 30 SECONDS	OFF	OFF
	GREEN	GREEN
	RED	RED
	RED	GREEN
	GREEN	GREEN
	RED	RED
	RED	GREEN
	GREEN	GREEN
REMOVE	OFF	OFF

When both LED's turn off, remove the magnet and the KCAP300 will be restored to normal operation with the default settings.

4.4 Setpoint Calibration (One Touch Calibration)

A typical application will require the switch to activate when the measured product reaches the probe. To set the action of the switch for this application, mount and wire the switch in its permanent location. Without product touching the probe, place the calibration magnet on the “X” position for more than 1 but less than 6 seconds. Move the magnet to the “S1” position for 2 seconds. The following sequence of lights will be observed during this operation:

TABLE 2		
OPERATION	LED 1	LED 2
NORMAL	GREEN or RED	OFF
1 SECOND < X < 6 SECONDS	OFF	OFF
S1	GREEN	OFF
	GREEN or RED	OFF

This procedure will establish the reference capacitance of the installation and create the setpoint of the switch. When the measured product touches the probe, the switch will activate. If this does not occur, the Sensitivity may need to be increased (Section 4.6.) In applications where the dielectric of the material being detected is greater than 10, the setpoint location can only be established in this manner.

The setpoint of the switch can be established with product touching the probe. In this case, the action of the relays will take place when the product level increases the sensed capacitance of the switch, typically a rising level. ABB does not recommend creating a setpoint for the KCAP300 in this manner.

4.5 Fail Safe / Relay Operation

The default setting for the Fail Safe or Relay Operation of the KCAP300 will be Low. This means the relays will be de-energized when the level is below the switch and energize when the switch point is reached. Likewise, setting the Fail Safe to High will cause to the relays to be energized when the level is below the setpoint and de-energize when the switch point is reached. To select the Fail Safe for the relays, place the magnet in the S1 position for 10 seconds. The following sequence of lights will be observed:

TABLE 3		
OPERATION	LED 1	LED 2
NORMAL	GREEN or RED	OFF
S1 = 10 SECONDS	OFF	OFF
REMOVE	“GREEN/RED”	OFF
“ _ ” - indicates a blinking LED		

Removing the magnet when LED1 is green will set the Fail Safe to Low. Removing the magnet when LED1 is red will set the Fail Safe to High.

4.6 SENSITIVITY / HYSTERESIS

The Sensitivity / Hysteresis of the KCAP300 will be set at a default of high, a value of 1.5pF. This means a change of 1.5pF from the set point will be required to activate the switch. This setting will allow switching in most applications. In applications of higher dielectric materials, it may be necessary to decrease the sensitivity to prevent false indications. In applications with lower dielectrics, it may be necessary to increase the sensitivity.

To access the Sensitivity Setup Mode, place the magnet on S2 for more than 1 second but less than 6 seconds. The following sequence of LED's will be observed:

TABLE 4		
OPERATION	LED 1	LED 2
NORMAL	GREEN or RED	OFF
1 SECOND < S2 < 6 SECONDS	OFF	OFF
	RED	"GREEN"
	OFF	OFF
S2 per Table 7	OFF	"GREEN"
" _ " - indicates a blinking LED		

While LED1 is lit red, LED2 will blink the current Sensitivity setting per Table 5.

TABLE 5				
LED 2 BLINKS	1	2	3	4
pF	0.5	1.5	6	32
SENSITIVITY	VERY HIGH	HIGH	MED	LOW

After LED1 turns "off", LED2 will blink in correspondence to the different Sensitivity settings per Table 5. Once the number of blinks required is reached, place the magnet on the S2 position. The sensitivity will be set, and the KCAP300 will return to normal operation. If a new sensitivity is not selected, the KCAP300 will return to its current operating mode without affecting a change. The default sensitivity setting is (HIGH), 1.5pF which is the Number 2 setting.

4.7 Time Delay

The KCAP300 with its default settings will activate the relays instantaneously when the switch point has been reached. In certain applications it may be necessary to delay the action of the relays in the switch. If this is desired, a Time Delay for the relays can be set. To enter the Time Delay Setup Mode, place the magnet on S1 for more than 1 second but less than 6 seconds then. The following sequence of LED's will be observed:

TABLE 6		
OPERATION	LED 1	LED 2
NORMAL	GREEN or RED	OFF
1 SECOND < S1 < 6 SECONDS	OFF	OFF
	"GREEN"	RED
	OFF	OFF
S1 per Table 5	"GREEN"	OFF
" _ " - indicates a blinking LED		

While LED2 is lit red, LED1 will blink the current Time Delay setting per Table 7.

TABLE 7			
LED 1 BLINKS	1	2	3
SECONDS	0	5	15

After LED2 turns "off", LED1 will blink in correspondence to the different Time Delay settings per Table 7. When the desired Time Delay is reached, place the magnet on the S1 position. The Time Delay will be set and the KCAP300 will return to normal operation. If a time delay is not selected, the KCAP300 will return to its current operating mode without changing the current Time Delay setting.

During normal operation of the switch if a Time Delay is selected other than 0 seconds, LED1 will change color when the switch point has been reached. The relays will respond after the elapsed Time Delay on both energize and de-energize actions.

5. TROUBLESHOOTING

5.1 “Out-of-Calibration” Indication

An “Out-of-Calibration” Indication does not mean the KCAP300 will not operate.

The KCAP300 uses its 3 element probe design and the KSHIELD™ software to operate in the presence of buildup. When the switch is installed it will be clean and free from buildup. When the switch is calibrated the reference capacitance and the setpoint capacitance are stored in the memory of the device. As deposits settle on the probe creating a buildup, the reference capacitance from the shield element will cause the reference to shift accordingly. Despite the shift in reference the sensed capacitance may still be affected.

To identify the presence of excessive buildup, an “Out-of-Calibration” Indication has been added to the software. For an “Out-of-Calibration” to occur one of two scenarios must take place.

1. The level of sensed capacitance is rising close to the switch point but does not surpass it. The sensed level remains close to the switch point for 25 minutes.
2. The level of sensed capacitance is falling towards the reset point but does not surpass it. The sensed level remains close to the reset point for 25 minutes.

An “Out-of-Calibration” Indication will occur when the probe is covered with buildup but the measured product is actually below the switch. To resolve the situation, recalibrate the switch using the procedure in Section 4.4 or remove the switch, clean off the excessive buildup, and reinstall the switch.

5.2 Symptoms and Remedies

Any failure of the KCAP300 can be defined as a negative reaction to an action. Each failure will have certain symptoms, which can direct the user to a possible cause and eventual remedy.

SYMPTOMS	POSSIBLE CAUSE	REMEDY
KCAP300 does not detect material.	Bad ground connection. Sensitivity set too low. Damaged electronics.	Ensure correct grounding of the device. Refer to Section 4.6 to increase sensitivity. Replace electronics module and recalibrate.
Unstable relay action.	Bad ground connection.	Ensure correct grounding of the device.
	Sensitivity set too high for high dielectric.	Refer to Section 4.6 to decrease sensitivity.
	Radio frequency interference.	Ensure housing cover is completely screwed into housing.
		Ensure proper grounding of the device.
	Agitation or waves in liquid.	Refer to Section 4.7 to increase Time Delay.
		Modify or change mounting to eliminate effects of fluid motion.
Lack of available power to switch.	Ensure proper input voltage and wattage. (Section 2.2).	
Damaged electronics.	Replace electronics module and recalibrate.	
LED2 is blinking Red.	"Out of Calibration" indication. (Section 5.1)	Recalibrate the setpoint. Section 4.4
		Ensure correct grounding of the device.
		Check for excessive buildup on the probe.
		Check the level in the vessel to ensure calibration is necessary.
	Damaged electronics.	Replace electronics module and recalibrate.

5.3 Warranty Statement

5 YEAR WARRANTY FOR:

KM26 Magnetic Liquid Level Gauges, Buoyancy Level Switches (LS20, MS50, MS10 & MS8), Magnetic Level Switches (MS30, MS21, MS40, MS41, PS35 & PS45), EC External Chambers and ST95 Seal Pots.

3 YEAR WARRANTY FOR:

KCAP300 & KCAP 400 capacitance switches.

2 YEAR WARRANTY FOR:

AT100 and AT200 series transmitters; VF20 and VF30 vibrating fork switches; RLT100 and RLT200 reed switch level transmitters; TX, TS, TQ, IX and IM thermal dispersion switches; MT2000 radar level transmitters; KP paddle switches; A02, A75 & A77 RF capacitance level switches and A38 RF capacitance level transmitters.

1 YEAR WARRANTY FOR:

KM50 gauging device; AT500 and AT600 series transmitters; LaserM and SureShot series laser transmitters; LPM 100 and 200 series digital indicators; DPM100 digital indicators; APM100 analog indicators; KVIEW series digital indicators and controllers; SF50 and SF60 vibrating fork switches, KB Electro-Mechanical Continuous Measuring Devices, KSONIK ultrasonic level switches, transmitters & transducers.

SPECIAL WARRANTY CONSIDERATIONS:

ABB will honor OEM warranties for items not manufactured by ABB (i.e. Palm Pilots).

ABB will repair or replace, at ABB's election, defective items which are returned to ABB by the original purchaser within the period specified above from the **shipment date** of the item and which is found, upon examination by ABB, to its satisfaction, to contain defects in materials or workmanship which arose only under normal use and service and which were not the result of either alterations, misuse, abuse, improper or inadequate adjustments, applications or servicing of the product. **ABB's warranty does not include onsite repair or services.** Field service rates can be supplied on request.

If a product is believed to be defective, the original purchaser shall notify ABB and request a Returned Material Authorization before returning the material to ABB, with transportation **prepaid** by the purchaser. (Request door to door delivery via New Orleans International Airport located in Louisiana, USA.) The product, with repaired or replaced parts, shall be returned to the purchaser at any point in the world with transportation prepaid by ABB for best-way transportation only. ABB is not responsible for expedited shipping charges. If the product is shipped to ABB freight collect, then it will be returned to the customer freight collect.

If inspection by ABB does not disclose any defects in material or workmanship, ABB's normal charges for repair and shipment shall apply (minimum 100.00 USD).

The materials of construction for all ABB products are clearly specified and it is the responsibility of the purchaser to determine the compatibility of the materials for the application.

THE FOREGOING WARRANTY IS ABB'S SOLE WARRANTY AND ALL OTHER WARRANTIES EXPRESSED, IMPLIED, OR STATUTORY, INCLUDING ANY IMPLIED WARRANTY OF MERCHANTABILITY OF FITNESS FOR A PARTICULAR PURPOSE, ARE EXCLUDED AND NEGATED TO THE MAXIMUM EXTENT PERMITTED BY LAW. NO PERSON OR REPRESENTATIVE IS AUTHORIZED TO EXTEND ANY OTHER WARRANTY OR CREATE FOR ABB ANY OTHER LIABILITY IN CONNECTION WITH THE SALE OF ABB'S PRODUCTS. THE REMEDIES SET FORTH IN THIS WARRANTY ARE EXCLUSIVE OF ALL OTHER REMEDIES AGAINST ABB. ABB SHALL NOT BE LIABLE FOR ANY CONSEQUENTIAL, INCIDENTAL, OR SPECIAL DAMAGES OF ANY KIND. ABB'S SOLE OBLIGATION SHALL BE TO REPAIR OR REPLACE PARTS (FOUND TO BE DEFECTIVE IN MATERIALS OR WORKMANSHIP) WHICH ARE RETURNED BY THE PURCHASER TO ABB.

5.4 Company Information

For advanced troubleshooting information or repairs, contact the ABB Factory:

Service Department
17100 Manchac Park Lane - Suite B
Baton Rouge, LA 70817 USA
Phone: +1 225 408 0800
Service: +1 225 408 0898
Service e-mail: service@us.abb.com

Contact us

ABB Inc.
Industrial Automation
125 E. County Line Road
Warminster, PA 18974 USA
Tel: +1 215 674 6000
Fax: +1 215 674 7183

ABB Inc.
17100 Manchac Park Lane - Suite B
Baton Rouge, LA 70817 USA
Phone: +1 225 408 0800
Service: +1 225 408 0898
Fax: +1 225 408 0897
Service e-mail: service@us.abb.com

ABB Engineering (Shanghai) Ltd.
No. 4528, KangXin Hwy.
Pudong New District
Shanghai, 201319, P.R. China
Phone: +86 10 64231407
Service: +86 21 61056421
Fax: +86 10 64371913
E-mail: norman-suijun.xia@cn.abb.com
Service e-mail: rola.li@cn.abb.com

www.abb.com/level

Note

We reserve the right to make technical changes or modify the contents of this document without prior notice. With regard to purchase orders, the agreed particulars shall prevail. ABB does not accept any responsibility whatsoever for potential errors or possible lack of information in this document.











We reserve all rights in this document and in the subject matter and illustrations contained therein. Any reproduction, disclosure to third parties or utilization of its contents - in whole or in parts - is forbidden without prior written consent of ABB.

Copyright© 2017 ABB
All rights reserved

01/KCAP300-EN Rev. E 07.2017



Our offering:

	Actuators and Positioners		Analytical Instruments
	Device Management, Fieldbus and Wireless		Flow Measurement
	Force Measurement		Level Measurement
	Natural Gas Measurement		Pressure Measurement
	Recorders and Controllers		Temperature Measurement

HMI – Automação e Instrumentação, Lda.

Travessa da Indústria, nº 111
4780-573 Santo Tirso
PORTUGAL

Tel. +351 252 850 501
Fax. +351 300 013 487

Web: www.hmi.pt

Email: hmi@hmi.pt