



FICHA TÉCNICA DE PRODUTO

PRODUCT DATASHEET

---

HMI – Automação e Instrumentação, Lda.

---

Rua dos 5 Caminhos, nº 570  
4780-382 Santo Tirso  
PORTUGAL

Tel. +351 252 850 501  
Fax. +351 300 013 487

Web: [www.hmi.pt](http://www.hmi.pt)

Email: [hmi@hmi.pt](mailto:hmi@hmi.pt)

ABB MEASUREMENT & ANALYTICS | DATA SHEET

## **AX430, AX433, AX413 and AX436**

Single and dual input analyzers  
for high level conductivity



---

## Measurement made easy

More processing power,  
higher performance

### Cost effective

- select one or two conductivity inputs or combine pH/Redox (ORP) with conductivity in one analyzer
- integral PID controller (AX430)

### Advanced measuring capabilities

- conductivity range up to 1,999 mS cm<sup>-1</sup>
- selectable concentration ranges:  
0 to 15 % NaOH, 0 to 18 % HCl, 0 to 20 % H<sub>2</sub>SO<sub>4</sub>,  
0 to 40 % H<sub>3</sub>PO<sub>4</sub>, 0 to 20 % NaCl and user-defined

### Dosing control functionality

- long dose diagnostic alarm
- initial charge function

### Reduced installation cost

- easy access terminations; reduced panel space

### High functionality at minimum cost

- three alarms and two fully-isolated current outputs
- direct linear, reverse acting or bi-linear output

### Expanded monitoring and control

- add-on option board provides a total of five alarm relays and four current outputs
- service logbook providing historical data

### Reduced yearly maintenance costs

- 12 to 30 V DC option negates the need for costly safety tests

### Wide range of applicability

- regeneration of ion exchangers
- municipal water phosphoric acid control
- food & beverage product / water interface detection
- clean-in-place concentration monitoring

## The AX400 series

AX400 analyzers incorporate the latest technology to provide highly reliable, flexible, feature-packed devices that satisfy a diverse range of process monitoring and control applications. The complete range encompasses solutions for pH / Redox (ORP), conductivity and dissolved oxygen.

AX43x analyzers enable continuous measurements of one or two conductivity points with simultaneous local display and retransmission. AX43x is used with the TB4 and AC400\* Series of insertion, immersion and flow-through, four-electrode conductivity cells providing measurements with exceptional accuracy and performance.

AX400 Series analyzers are available for either wall-/pipe- or panel-mounting and are rated to IP65.

\* Check with factory for availability.

## High functionality as standard

All versions are supplied with two, fully-isolated current outputs as standard, that can be assigned to the measured parameter, sample temperature or any appropriate calculated variables.

Three programmable relay set points are available which can also be assigned as required.

Innovative features such as a power saving display and a diagnostic current output option all contribute to a low cost of ownership.

## Plug-and-produce expanded control

An advanced function card provides an additional two current outputs and two further alarm relays that can be assigned to either measured values or sample temperature.

ABB Plug-and-Produce software automatically reconfigures the analyzer if an option board is added later. No user programming is necessary.

A real-time clock and logbook are also included, making the full-facility versions extremely powerful and versatile.

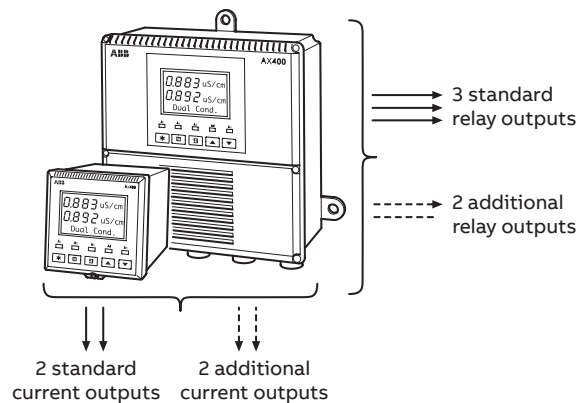

AX400 outputs

## Significantly reduced maintenance costs

The AX400 analyzers are supplied as standard for 85 to 265 V AC operation. There are no inner switches to set.

They can also be provided for 24 V AC or 12 to 30 V DC supply and recognize automatically which of the two supplies is being used. 24 V DC operation reduces maintenance costs significantly by negating the need for costly, yearly safety tests to ensure compliance with safety procedures.

### Energy saving display

The backlit display has been designed to operate in all types of environments and shows both the measured parameter(s) and, on a separate 16-character display line, diagnostic and computed information.

On dual-input analyzers both measured parameters are displayed simultaneously.

For conservation of energy, the backlight can be set to switch off automatically after 60 seconds of inactivity.



Backlight can be set to switch off when inactive

### Easy access installation terminals

Easy access to the terminations ensures rapid and cost-effective installation. The wall- / pipe-mount version has been designed to ensure that cable connection is simple and convenient. Ingress protection of the electronics section is retained even when the terminal compartment is opened.

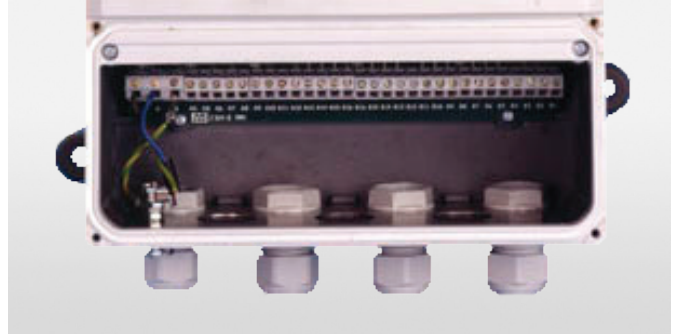

AX400 termination chamber makes access easy

## Advanced conductivity and concentration monitoring

AX43x conductivity analyzers measure up to  $1,999\text{mS cm}^{-1}$  enabling operation in the majority of high concentration processes. Automatic and manual temperature compensations enable effective measurements up to  $300\text{ }^{\circ}\text{C}$  ( $572\text{ }^{\circ}\text{F}$ ).

In addition, these analyzers enable operation directly in terms of concentration: 0 to 15 % NaOH, 18 % HCl, 20 %  $\text{H}_2\text{SO}_4$ , 40 %  $\text{H}_3\text{PO}_4$ , 20 % NaCl and user-defined. This is particularly suited for strength-monitoring of ion exchange regenerant acid and alkali.

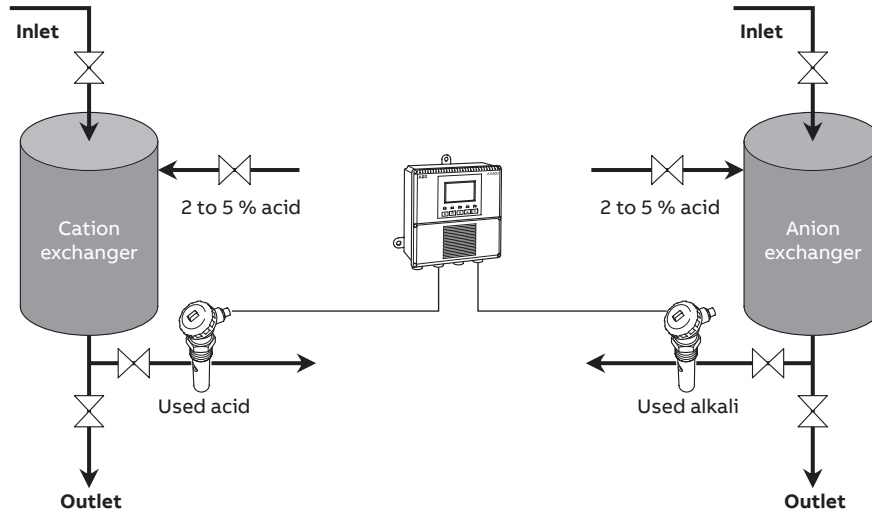

Dual-input monitoring ion exchange regenerants

## Dosing control functionality

The analyzer controls phosphoric acid strength in water treatment plants. In food and beverage CIP and bottle-washing processes plant, AX43x analyzers provide cost-effective control for the strength of caustic and acid detergents. It can be used to detect the presence of detergent, rinse water or product, safely protecting the product from detergent ingress. It also optimizes product yield, ensuring that the maximum quantity of product is retained rather than sent to drain.

In addition, the analyzers provide the freedom to program a user's own conductivity-to-concentration curve. This enables configuration for non-standard CIP detergents or specific reagent mixtures.

Detection of detergent in rinse water reduces costs by recovering lost cleaning agents and reducing the load on the effluent treatment plant.

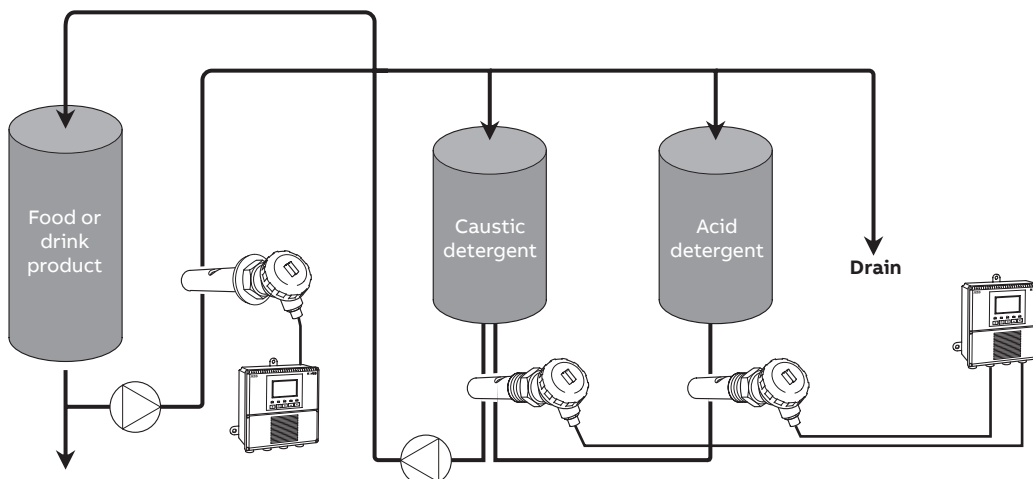

Cost-effective control of CIP plant

## AX436 combined conductivity and pH

The AX436 version measures conductivity and pH with the same analyzer. The option board provides the capability to retransmit conductivity, pH and both sample temperatures. This is particularly useful in the paper industry, reducing the investment in separate instruments, for example, when used on white water or the head box.



Simultaneous conductivity and pH measurement

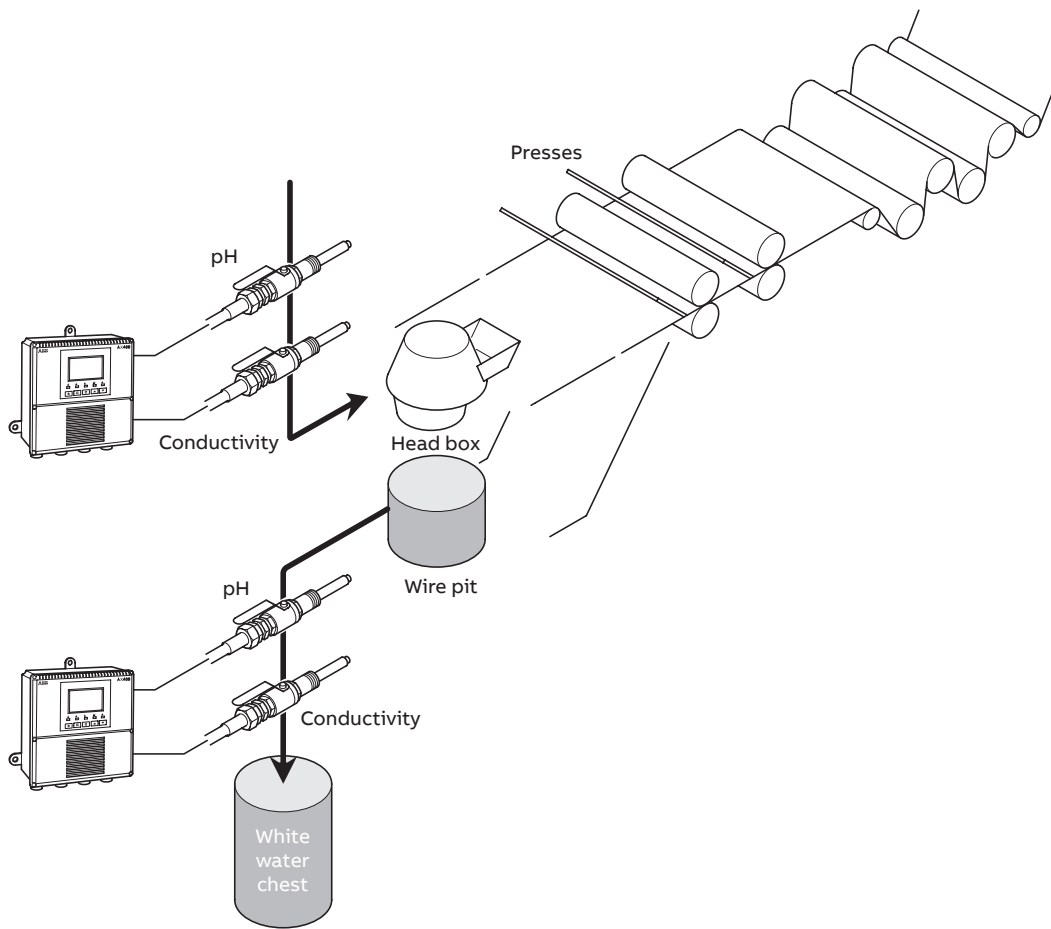

Dual input measurement

## Long-dose alarm function

An important diagnostic capability incorporated in AX43x analyzers is the long-dose alarm function. This is useful for occasions when faults occur in the dosing system.

The analyzers can be configured to provide an alarm if a set point has not been reached within a specified time. This valuable facility provides a warning that could indicate a loss of dosing chemicals, a leakage or a costly pump failure.

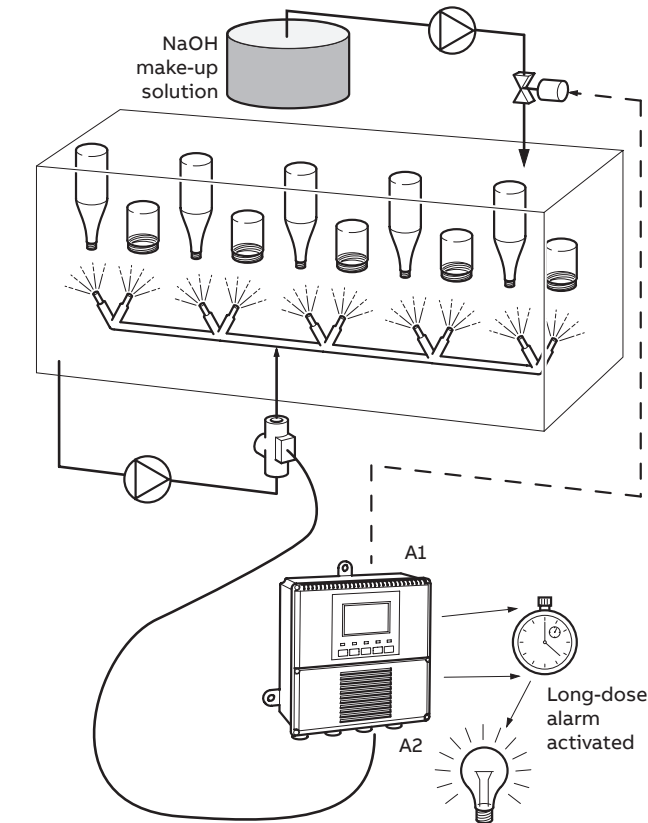

Long-dose alarm warns of dosing systems faults

## Initial charge function

In some applications, fresh dosing chemical reagent is made up every few days. For example, in bottle-washing plants the caustic solution can become dirty and must be replaced regularly. In the case of a new charge, i.e. making up a fresh reagent dilution, a general long-dose alarm could be initiated before the reagent had attained the correct concentration.

AX43x analyzers provide a simple solution by having a pre-configurable initial charge function. A simple button press from the operator page disables the general long-dose alarm until the conductivity or concentration reaches 90 % of the set point. The initial charge period is also user-programmable.

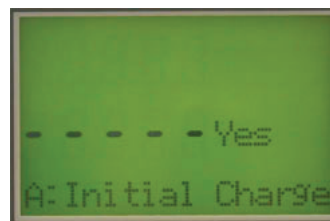
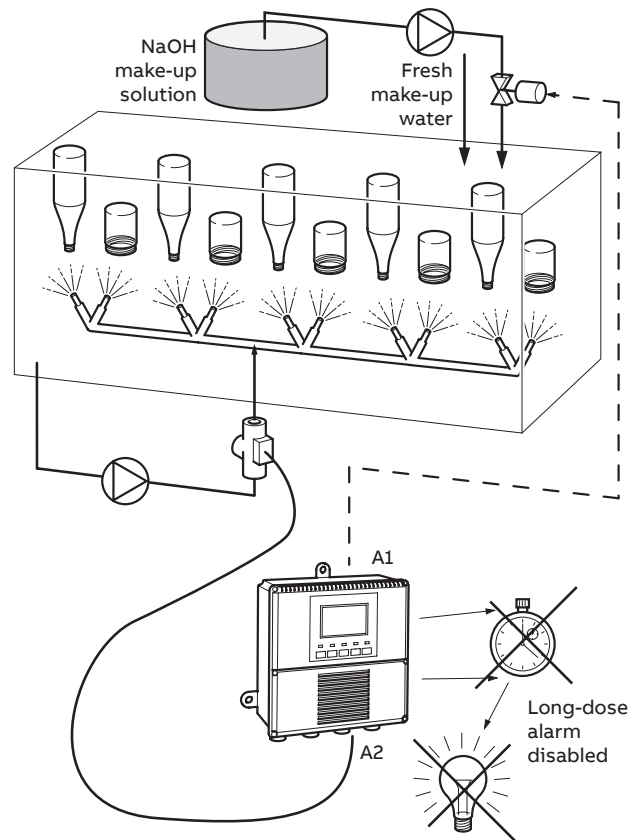

Initial charge function when making fresh reagent



## AX430 integral P, PI and PID control

The single input AX430 analyzers incorporate three-term PID control, offering three modes of sophisticated control: analog, pulse length (time proportional) and pulse frequency. These are supplied as standard and can be operated in direct- or reverse-acting mode, dependent upon the application.

### Auto / Manual and bumpless transfer

An auto / manual feature is incorporated for rapid manual access to the control functions. The controller facilitates bumpless transfer between manual and auto modes, providing the measured variable is within the proportional band and some integral action time has been programmed.

### Current output proportional control

In this case, the control signal is provided by the 4 to 20 mA output of the AX430 analyzer rather than using the alarm / control contacts. The magnitude of the current output changes in proportion to the deviation from set point. This method is used generally with motorized valves or when controlling the speed of dosing pumps with a 4 to 20 mA proportional input.

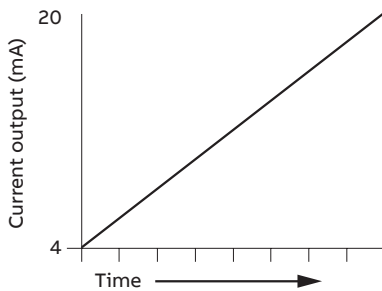

Current acting control

### Time proportioning control (pulse length)

With time proportioning control, the AX430 analyzer's control signal output is in pulses, the duration of which changes in proportion to the system error. The pulses are delivered by varying the length of time that the alarm / control contact is activated.

Time proportioning control is generally used to control dosing by low-cost solenoid valves or metering pumps and is also known as pulse-length proportional or 'mark space' control.

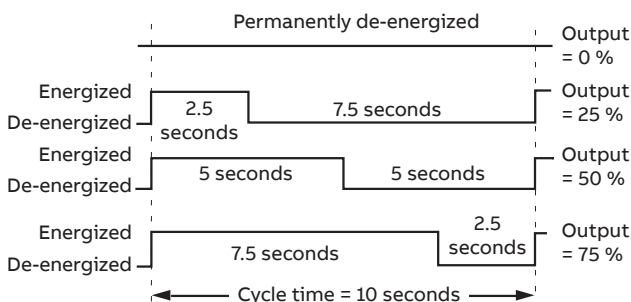

Time proportioning control

### Pulse-frequency proportional control

Impulse pumps dosing chemical reagents are controlled easily by the AX430 analyzer's pulse-frequency proportional control output. In this case, the pulse length of the alarm / control contact is fixed and the frequency of the delivered pulses increases in proportion to the system error, as set by the proportional band. Diaphragm metering pumps must have a remote pulse input capability in order to utilize this function.

Pulse-frequency control in the AX430 analyzer operates by pulsing a relay on for 300ms and off for a period of time determined by the pulse frequency. The pulse frequency (PFR) is adjustable between 1 and 120 pulses per minute. The greater the difference between the measured variable and the set point the greater the pulse frequency.

### Example

If the pulse frequency is set at 120 pulses per minute and the percentage output is 100 % then the pulse rate is 2 pulses per second. If the percentage output is reduced to 50 %, the pulse rate falls to one pulse per second.

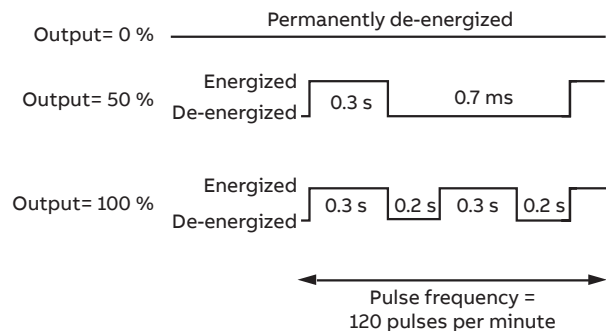

Pulse-frequency proportional control

### Power failure recovery

In the event of a power failure the user can configure the control mode to be Auto, Manual or Last. This optimizes control conditions on power-up to ensure rapid recovery of process control.

## Specification

### Conductivity

#### Range

Conductivity programmable	0.000 to 1999 mS cm <sup>-1</sup> (uncompensated)
Concentration	0.000 to 1.999 digits (user configurable)
Selectable concentration ranges	0 to 15 % NaOH 0 to 18 % HCl 0 to 20 % H <sub>2</sub> SO <sub>4</sub> 0 to 40 % H <sub>3</sub> PO <sub>4</sub> 0 to 20 % NaCl User-defined table
Temperature	-20 to 300 °C (-4 to 572 °F)

#### Sensor full scale measurement ranges

(a) TB4 Group A and AC400 cells	0 to 1,999 mS cm <sup>-1</sup> (uncompensated)
(b) TB4 Group B cells	0 to 1,999 μS cm <sup>-1</sup> (uncompensated)

#### Minimum span

(a) TB4 Group A and AC400 cells	100.0 μS cm <sup>-1</sup>
(b) TB4 Group B cells	10.00 μS cm <sup>-1</sup>
Concentration	5% of the maximum set concentration range
Temperature	10 °C (50 °F)

**Note.** Refer to corresponding data sheets for process limit specifications of TB4 and AC400 cells.

#### Resolution, display

Conductivity	
(a) TB4 Group A and AC400 cells	0.1 μS cm <sup>-1</sup> 0.1 mS cm <sup>-1</sup>
(b) TB4 Group B cells	0.01 μS cm <sup>-1</sup>
Concentration	0.001 digits (configuration dependent)
Temperature	0.1 °C (0.1 °F)

#### Accuracy, display

Conductivity	±0.5 % measurement range per decade
Temperature	10 °C (21 °F)

#### Display temperature range

-20 to 300 °C (4 to 572 °F)

#### Temperature sensor

Pt1000 or 3k Balco

#### Temperature coefficient

Programmable 0 to 9.99 %/ °C and fixed temperature compensation curves (programmable) for acids and neutral salt

#### Reference temperature

25 °C (77 °F)

#### Dosing control functions

Long-dose alarm	0 to 10 mins. (user-configurable)
Initial charge function	0 to 30 mins. (user-configurable)

### Display

#### Type

Dual 5-digit, 7-segment backlit LCD

#### Information

16-character, single line dot-matrix

#### Energy-saving function

Backlit LCD configurable as ON or Auto-Off after 60 s

#### Logbook\*

Electronic record of major process events and calibration data

#### Real-time clock\*

Records time for logbook and auto-manual functions

#### Retransmission outputs

2 (4 optional) fully-isolated standard

### Relay outputs – on/off

#### Number of relays

Three supplied as standard or five with option board fitted

#### Number of set points

Three supplied as standard or five with option board fitted

#### Set point adjustment

Configurable as normal or failsafe high / low, bandwidth alarm (composite high/low) or diagnostic alert

#### Hysteresis of reading

Programmable 0 to 5 % in 0.1 % increments

#### Delay

Programmable 0 to 60 s in 1 s intervals

#### Relay contacts

Single-pole changeover  
Rating 5 A, 115 / 230 V AC, 5 A DC

#### Insulation

2 kV RMS contacts to earth / ground

### Analog outputs

#### Number of current outputs (fully isolated)

Two supplied as standard or four with option board fitted

#### Output range

- 0 to 10, 0 to 20 or 4 to 20 mA
- Analog output programmable to any value between 0 and 22 mA to indicate system failure

#### Accuracy

±0.25 % FSD, ±0.5 % of reading (whichever is the greater)

#### Resolution

0.1 % at 10 mA, 0.05 % at 20 mA

#### Maximum load resistance

750 Ω at 20 mA

#### Configuration

Can be assigned to either measured variable or either sample temperature

\*Available if option board is fitted.

## ...Specification

### Digital communications

#### Communications

Profibus DP (with option board fitted)

### Control function – AX430 only

#### Controller type

P, PI, PID (configurable)

#### Control outputs

#### Analog

Current output control (0 to 100 %)

#### Time proportioning cycle time

1.0 to 300.0 s, programmable in increments of 0.1 s

#### Pulse frequency

1 to 120 pulses per minute, programmable in increments of 1 pulse per minute

#### Controller action

Direct or reverse

#### Proportional band

0.1 to 999.9 %, programmable in increments of 0.1 %

#### Integral action time (Integral reset)

1 to 7200 s, programmable in increments of 1 s (0 = Off)

#### Derivative

0.1 to 999.9 s in increments of 0.1 s – available only for single set point control

#### Auto / Manual

User-programmable

### Access to functions

#### Direct keypad access

- Measurement, maintenance, configuration, diagnostics or service functions
- Performed without external equipment or internal jumpers

### Mechanical data

#### Wall- / Pipe-mount versions

- IP65 (not evaluated under UL certification)
- Dimensions (height, width, depth)  
192 x 230 x 94 mm (7.56 x 9.06 x 3.7 in.)
- Weight 1 kg (2.2 lb.)

#### Panel-mount versions

- IP65 (front only)
- Dimensions (height, width, depth)  
96 x 96 x 162 mm (3.78 x 3.78 x 6.38 in.)
- Weight 0.6 kg (1.32 lb.)

#### Cable entry types

Standard	5 or 7 x M20 cable glands
North American	7 x knockouts suitable for ½ in. Hubble gland

### Power supply

#### Voltage requirements

- 100 to 240 V AC, 50 / 60 Hz (90 V min. to 264 V max. AC)
- 12 to 30 V DC

#### Power consumption

10 W

#### Insulation

Mains to earth (line to ground) 2 kV RMS

### Environmental data

#### Operating temperature limits

–20 to 55 °C (–4 to 131 °F)

#### Storage temperature limits

–25 to 75 °C (–13 to 167 °F)

#### Operating humidity limits

Up to 95 %RH non condensing

### EMC

#### Emissions and immunity

Meets requirements of:

- EN61326 (for an industrial environment)
- EN50081-2
- EN50082-2

### Approvals, certification and safety

#### Safety approval

- UL
- CE mark

#### CE mark

Covers EMC & LV Directives (including latest version EN 61010)

#### General safety

- EN61010-1
- Overvoltage Class II on inputs and outputs
- Pollution category 2

### Languages

#### Languages configurable:

- English
- French
- German
- Italian
- Spanish

## Overall dimensions

Dimensions in mm (in.)

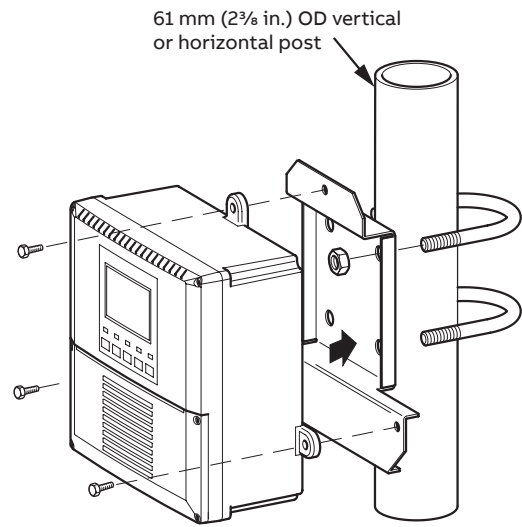
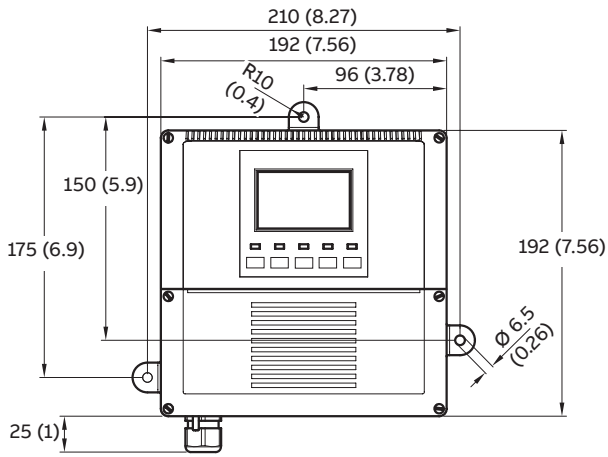

Pipe-mount detail

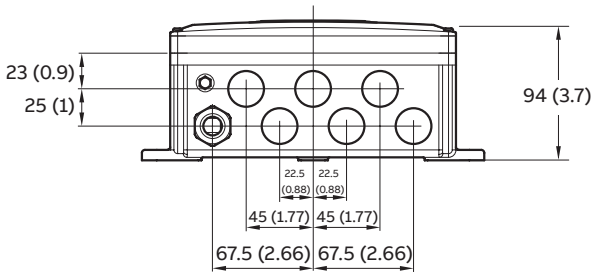

Wall- / Pipe-mount version

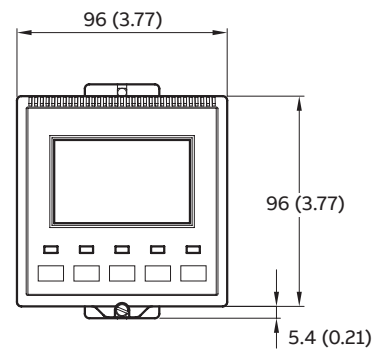
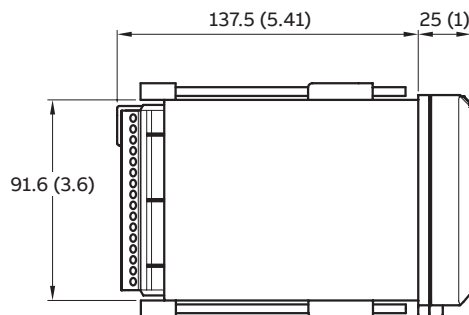
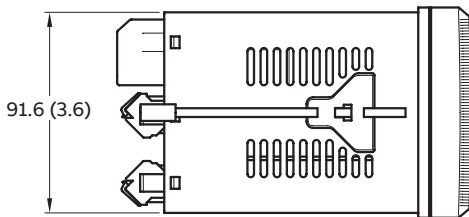

Panel-mount version

# Electrical connections

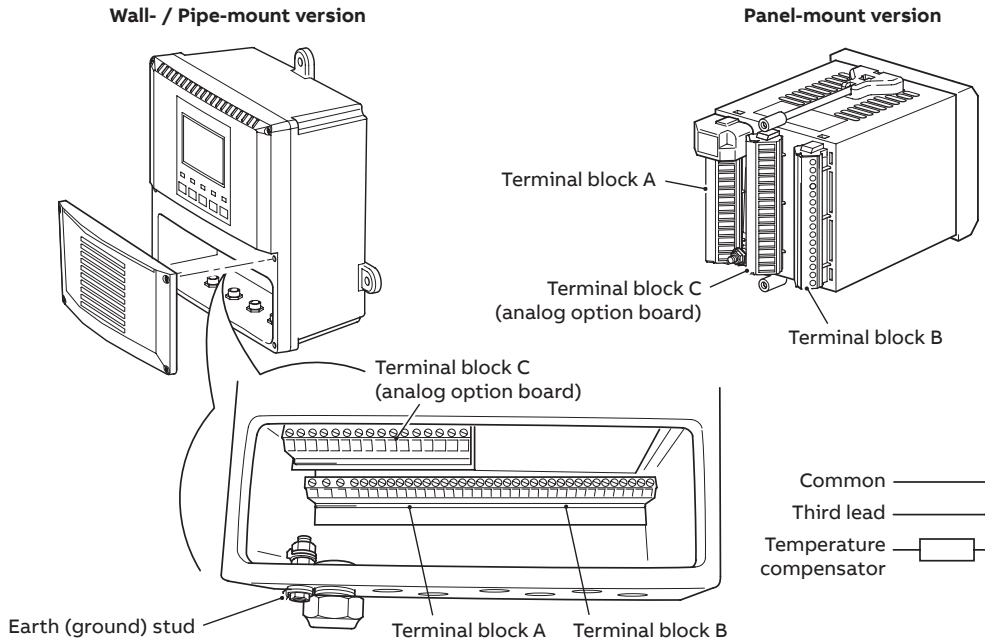

**Terminal block A**

1	L	Live
2	N	Neutral
3	E	Earth
4	A4	C
5	A5	NC
6	A6	NO
7	A7	C
8	A8	NC
9	A9	NO
10	A10	C
11	A11	NC
12	A12	NO
13	A13	+
14	A14	-
15	A15	+
16	A16	-

Relay 1: A4, A5, A6  
Relay 2: A7, A8, A9  
Relay 3: A10, A11, A12  
Analog output 1: A13, A14  
Analog output 2: A15, A16

**Terminal block C (analog option board)**

1	C1	Not used
2	C2	Not used
3	C3	Profibus – DP A
4	C4	Profibus – DP B
5	C5	Profibus earth
6	C6	Not used
7	C7	C
8	C8	NC
9	C9	NO
10	C10	C
11	C11	NC
12	C12	NO
13	C13	+
14	C14	-
15	C15	+
16	C16	-

Relay 4: C8, C9  
Relay 5: C10, C11, C12  
Analog output 3: C13, C14  
Analog output 4: C15, C16

**Terminal block B (see table below)**

1	B1
2	B2
3	B3
4	B4
5	B5
6	B6
7	B7
8	B8
9	B9
10	B10
11	B11
12	B12
13	B13
14	B14
15	B15
16	B16

**Terminal block B**

Sensor B	Sensor A	TB4 or AC400 4-electrode conductivity cell connections	TB4 series connections
B1	B9	Temperature compensator common	Blue
B2	B10	Link B10 and B9 (and B2 and B1 if dual input analyzer)	None*
B3	B11	Temperature compensator	Yellow
B4	B12	Screen	Dark green
B5	B13	Drive -ve	Green
B6	B14	Sense -ve	Red
B7	B15	Sense +ve	White
B8	B16	Drive +ve	Black

\*For conductivity sensors without a 3-wire temperature element, link terminals B1 and B2 and terminals B9 and B10.

## Ordering information





Single and dual input analyzers for high level conductivity, models AX430, AX433, AX413 and AX436	AX4	X	X	X	X	X	0	X
<b>First process variable (PV1)</b>								
Conductivity 0 to 10,000 $\mu\text{S cm}^{-1}$ for 2-electrode sensors		1						
Conductivity 0 to 1,999 $\text{mS cm}^{-1}$ for 4-electrode sensors		3						
Conductivity USP<645> for 2-electrode sensors		5						
pH/Redox (ORP)		6						
Dissolved oxygen		8						
<b>Second process variable (PV2)*</b>								
No second process variable – select for PID control of PV1			0					
Conductivity 0 to 10,000 $\mu\text{S cm}^{-1}$ for 2-electrode sensors			1					
Conductivity 0 to 1,999 $\text{mS cm}^{-1}$ for 4-electrode sensors**			3					
Conductivity USP<645> for 2-electrode sensors			5					
pH/Redox (ORP)			6					
Dissolved oxygen			8					
<b>Enclosure types</b>								
<b>Wall-mount IP65, general</b>								
Wall-mount – cable glands fitted				1				
Pipe-mount				2				
<b>Wall-mount IP65, North American</b>								
Wall-mount				6				
Pipe-mount				7				
<b>Panel-mount, universal</b>								
Panel-mount**				5				
<b>Advanced functions and communications</b>								
Basic (2 current outputs + 3 relays)						0		
Advanced (4 current outputs + 5 relays + logbook)						1		
Profibus DP, basic (2 current outputs + 3 relays)**						2		
Profibus DP, advanced (4 current outputs + 5 relays + logbook)**						3		
<b>Power supply</b>								
100 to 240 V AC 50 / 60 Hz							0	
12 to 30 V DC							1	
<b>Reserved</b>								
								0
<b>Manual</b>								
English								1
French								2
Italian								3
German								4
Spanish								5

\* When ordering units with a second process variable (PV2) the code digit for PV2 in the order code number must be equal to, or greater than, the code digit for PV1 (for example, AX436 is permissible, AX463 is not permissible).

\*\* Profibus DP is not available in panel-mount housing when 0 to 1,999 mS/cm is selected as the second process variable (PV2).



## Our offering:

	Actuators and Positioners		Analytical Instruments
	Device Management, Fieldbus and Wireless		Flow Measurement
	Force Measurement		Level Measurement
	Natural Gas Measurement		Pressure Measurement
	Recorders and Controllers		Temperature Measurement

---

HMI – Automação e Instrumentação, Lda.

---

Rua dos 5 Caminhos, nº 570  
4780-382 Santo Tirso  
PORTUGAL

Tel. +351 252 850 501  
Fax. +351 300 013 487

Web: [www.hmi.pt](http://www.hmi.pt)

Email: [hmi@hmi.pt](mailto:hmi@hmi.pt)





---

**ABB Limited****Measurement & Analytics**

Oldends Lane, Stonehouse  
Gloucestershire, GL10 3TA  
UK

Tel: +44 (0)1453 826 661

Fax: +44 (0)1453 829 671

**ABB Inc.****Measurement & Analytics**

125 E. County Line Road  
Warminster, PA 18974

USA

Tel: +1 215 674 6000

Fax: +1 215 674 7183

**[abb.com/measurement](http://abb.com/measurement)**

---

We reserve the right to make technical changes or modify the contents of this document without prior notice. With regard to purchase orders, the agreed particulars shall prevail. ABB does not accept any responsibility whatsoever for potential errors or possible lack of information in this document.

We reserve all rights in this document and in the subject matter and illustrations contained therein. Any reproduction, disclosure to third parties or utilization of its contents – in whole or in parts – is forbidden without prior written consent of ABB.