



hmi

high-accuracy
measurement
instruments

FICHA TÉCNICA DE PRODUTO

PRODUCT DATASHEET

HMI – Automação e Instrumentação, Lda.

Travessa da Indústria, nº 111
4780-573 Santo Tirso
PORTUGAL

Tel. +351 252 850 501
Fax. +351 300 013 487

Web: www.hmi.pt

Email: hmi@hmi.pt

ABB MEASUREMENT & ANALYTICS | DATA SHEET

Navigator 600 Phosphate

Phosphate analyzer



Measurement made easy

Cost-effective automated monitoring of phosphate for steam raising applications

Lowest cost-of-ownership

- up to 90 % lower reagent consumption than competitors' analyzers
- labour-saving 5 minute annual maintenance and up to 6 months unattended operation
- field upgradeable from 2 to 4; 2 to 6 or 4 to 6 streams

Easy to use

- familiar Windows™ menu system
- built-in context-sensitive help

Full communications

- web- and ftp-enabled for easy data file access, remote viewing and configuration
- optional Profibus® DP V1.0

Fast, accurate and reliable

- automatic cleaning, automatic calibration and automatic zero deliver high accuracy measurements
- extensive electronics, measurement and maintenance diagnostics ensure high availability
- indication in PO₄ or P
- temperature-controlled reaction and measurement section for optimum response

Introduction

Many years of experience and innovation in the design and successful application of continuous chemical analyzers has been combined with the latest electronics and production technologies to produce the Navigator 600 Series of analyzers from ABB.

Developed as fully continuous analyzers offering wide dynamic ranging, the Navigator 600 Series incorporates greater simplicity and functionality than ever before. Based on colorimetric techniques, they feature a liquid-handling section carefully designed to reduce routine maintenance. Utilizing powerful electronics, advanced features such as automatic calibration, continuous sample analysis and programmable multi-stream switching ensure accurate and simple measurement of phosphate.

Process data, as well as the content of alarm and audit logs, can be saved to a removable SD card in binary and comma-delimited formats for record keeping and analysis using ABB's DataManager data analysis software package.

A very low cost of ownership has been achieved by reducing the reagent consumption and simplifying the maintenance requirements.

The size of the analyzer has been reduced to a compact, ergonomically-designed, wall-mounted case containing all the components.

Operation

General

The Navigator 600 Phosphate is an on-line analyzer, designed to provide continuous monitoring of phosphate concentration, utilizing a standard colorimetric analysis principle.

Liquid handling

The chemistry employed for phosphate measurement is the industry standard Molybdenum Blue reaction. Sample and reagents are drawn into the analyzer by two multichannel peristaltic pumps. These are designed and constructed to ensure that only simple yearly maintenance is required. The reagents are added to the sample in a temperature-controlled reaction block and the fully reacted sample is then passed through an in-line measuring cuvette.

The optical measuring system enables accurate detection of phosphate concentrations from 0 to 15 ppm phosphate (PO_4) (0 to 5 ppm phosphorous [P]).

The analyzer also includes a manual sampling facility that enables the analysis of grab samples.



Figure 1 Liquid handling section

Solution replacement

	Continuous
Reagents	3 months
Calibration Standard	3 months
Cleaning Solution	3 months

Electronics

The electronics are mounted on the analyzer's back plate with the display and key pad accessible from the front of the unit. Indication of all parameters is provided by a large backlit LCD display that is easy to read in all light conditions. Under normal operating conditions, measured values are displayed; programming data is displayed during set-up and also on demand. Units and range of measurement, alarm values and standard solution values are examples of the many programmable functions.

Keeping simplicity of operation at the forefront of design, six fingertip-operated tactile membrane switches control local operation of the analyzer and provide easy access to all parameters.

The Navigator 600 Phosphate is provided with 4 dedicated relays, 6 user-programmable relays and 6 current outputs as standard. Profibus DP V1.0 is available as an option.

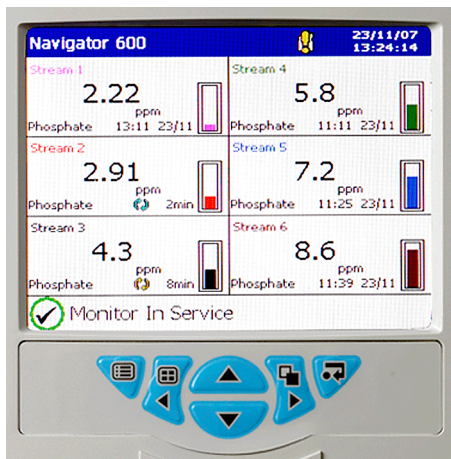

Figure 2 Display and keypad

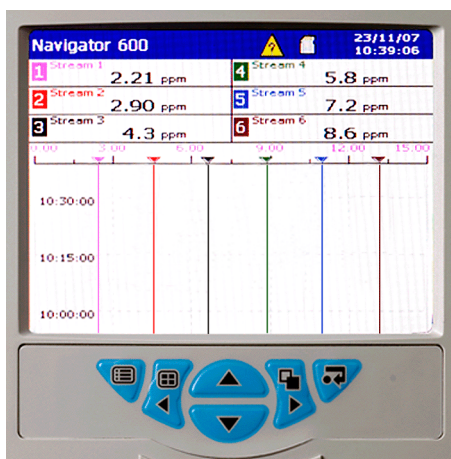

Figure 3 Chart view display

Ethernet communications

The Navigator 600 Phosphate can provide 10BaseT Ethernet communications via a standard RJ45 connector and uses industry-standard protocols TCP/IP, FTP and HTTP. The use of standard protocols enables easy connection into existing PC networks.

Data file access via FTP (File Transfer Protocol)

The Navigator 600 Phosphate features FTP server functionality. The FTP server in the analyzer is used to access its file system from a remote station on a network. This requires an FTP client on the host PC. Both MS-DOS® and Microsoft® Internet Explorer version 5.5 or later can be used as an FTP client.

- Using a standard web-browser or other FTP client, data files contained within the analyzer's memory or memory card can be accessed remotely and transferred to a PC or network drive.
- Four individual FTP users' names and passwords can be programmed into the Navigator 600 Phosphate. An access level can be configured for each user.
- All FTP log-on activity is recorded in the audit log of the instrument.
- Using ABB's data file transfer scheduler program, data files from multiple instruments can be backed-up automatically to a PC or network drive for long-term storage, ensuring the security of valuable process data and minimizing the operator intervention required.

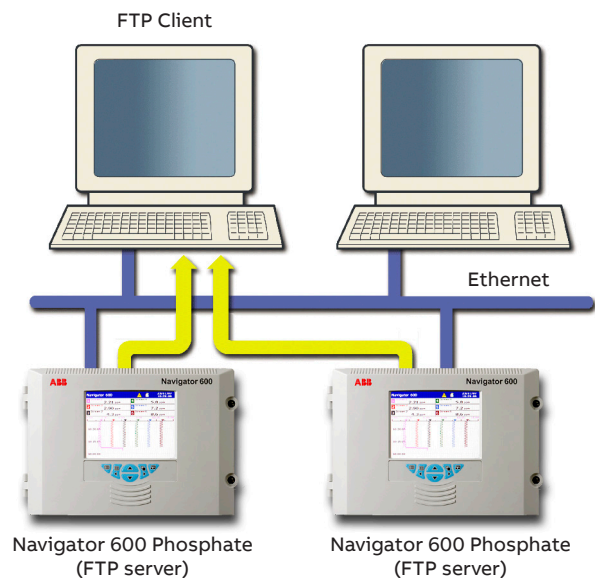

Embedded web server

The Navigator 600 Phosphate has an embedded web-server that provides access to web pages created within the instrument. The use of HTTP (Hyper Text Transfer Protocol) enables standard web browsers to view these pages.

- Accessible through the web pages are the current display of the analyzer, detailed information on stream values, reagent and solution levels, measurement status and other key information.
- The audit and alarm logs stored in the Navigator 600 Phosphate's internal buffer memory and memory card can be viewed on the web pages.
- Operator messages can be entered via the web server, enabling comments to be logged to the instrument.
- The web pages and the information they contain are refreshed regularly, enabling them to be used as a supervision tool.
- The analyzer's configuration can be selected from an existing configuration in the internal memory or a new configuration file transferred to the instrument via FTP.
- The analyzer's real-time clock can be set via the web server. Alternatively, the clocks of multiple analyzers can be synchronized using ABB's File Transfer Scheduler software.

Email notification

Via the Navigator 600 Phosphate's built-in SMTP client, the analyzer is able to email notification of important events. Emails triggered from alarms or other critical events can be sent to multiple recipients. The analyzer can also be programmed to email reports of the current measurement status or other parameters at specific times during the day.

Profibus

The Navigator 600 Phosphate can be equipped (option) with Profibus DP V1.0 to enable full communications and control integration with distributed control systems.

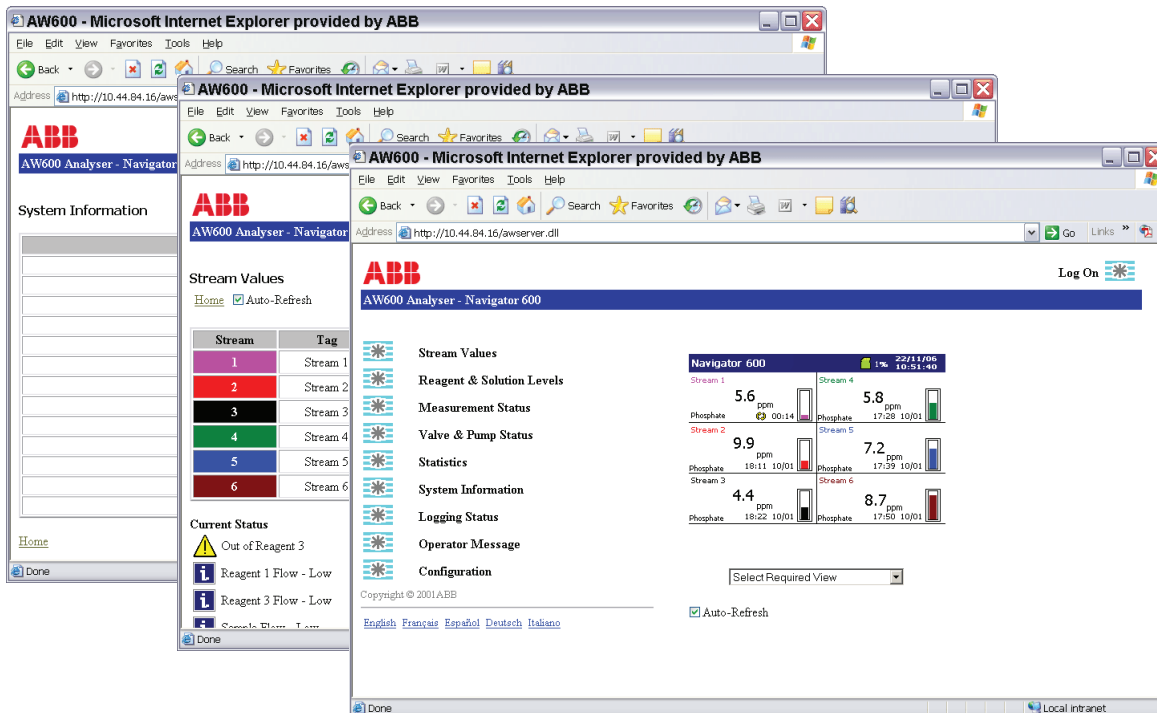

Maintenance

The analyzer has been designed to maximize on-line availability by reducing routine maintenance to a minimum.

Yearly maintenance consists of simply replacing pump capstans and pump tube assemblies, an operation that can take as little as five minutes.



Figure 4 Simple to replace pump tube assemblies

Fully automatic calibration, zeroing and cleaning functions enable the analyzer to keep itself operational with minimal manual intervention. A predictive alarm alerts the user before cleaning, calibration or reagent solution replacement is required.

Options

Multi-stream facility

A fully programmable multi-stream option is available on the Navigator 600 Phosphate on-line analyzer, providing up to six-stream capability including individual current output and visual indication as well as user-programmable stream sequencing.

The analyzers are designed to be easily upgradeable in the field from 2 to 4 or 6 streams and from 4 to 6 streams.

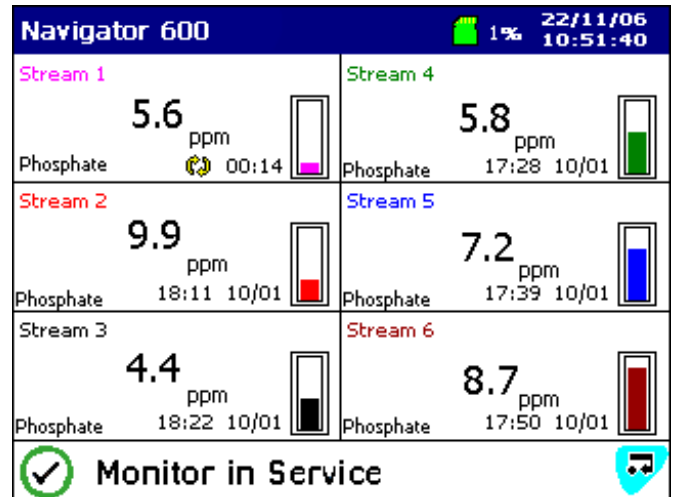

Figure 5 Six stream display

Specification

Phosphate measurement

Range

Fully user programmable 0 to 15 ppm PO₄ (0 to 5 ppm P),
minimum range 0 to 1 ppm PO₄ (0 to 0.33 ppm P)

Measurement modes

Continuous

Continuous measurement operation

Sample stream selection

Available in 1, 2, 4 or 6 streams (4 and 6 stream configurations can accommodate 3 and 5 streams respectively, if required)

Measurement performance

Response time

<15 mins. (90 % step change)

Typical accuracy

- <±3 % of reading or ±0.1 ppm (whichever is the greater) over the range 0 to 10 ppm PO₄
- <±5 % of reading over the range 10 to 15 ppm PO₄

Repeatability

- <±1.5 % of reading or ±0.05 ppm (whichever is the greater) over the range 0 to 10 ppm PO₄
- <±2.5 % of reading over the range 10 to 15 ppm PO₄

Range

Auto Ranging 0.00 to 2.99 /3.0 to 15.0

Solution requirements

Number

- 2 reagents
- 2 standard solution
- 1 cleaning solution

Volume

- 2.5 l max. per reagent
- 500 ml per standard solution
- 500 ml cleaning solution

Reagent consumption

Continuous operation mode

2.5 l max. per 90 days

Display

- Color, passive matrix, liquid crystal display (LCD) with built-in backlight and contrast adjustment
- Diagonal display area 144 mm (5.7 in.)
- 76800 pixel display*

*A small percentage of the display pixels may be either constantly active or inactive. Max. percentage of inoperative pixels <0.01%.

Dedicated operator keys

Group select / left cursor

View select / right cursor

Menu key

Up / Increment key

Down / Decrement key

Enter key

Mechanical data

Ingress protection

IP31** – Wet section (critical components IP66)

IP66 – Transmitter

Dimensions

Height 638 mm (25.1 in.) plus constant head bracket 186 mm (7.3 in.)

Width 271 mm (10.7 in.)

Depth 182 mm (7.2 in.)

Weight 15 kg (33 lbs)

Materials of construction

Electronics enclosure 20 % glass loaded polypropylene

Main enclosure Noryl

Lower tray 10 % glass loaded polypropylene

Door Acrylic

Environmental data

Ambient operating temperature

5 to 45 °C (41 to 113 °F)

Sample temperature

5 to 55 °C (41 to 131 °F)

Sample particulate

<60 microns

<10 mg/l-1

Sample flow rate

>20 mls/min / <500 ml/min

Storage temperature

-20 to 75 °C (-4 ... 167 °F)

Ambient operating humidity

Up to 95 % RH non-condensing

**Not evaluated for UL or CB

...Specification

Electrical

Supply ranges

- 110 to 240 V max. AC 50/60 Hz ± 10 %
(90 to 264 V AC, 45/65 Hz)
- 18 to 36 V DC (optional)

Power consumption

- 75 W max. – AC
- 100 W max. – DC

Analog outputs

Single and multi-stream analyzers

6 isolated current outputs, fully assignable and programmable over a 0 to 20 mA range (up to 22 mA if required)

Alarms / Relay outputs

Single and multi-stream instruments

One per unit:

- Out of service alarm relay
- Calibration in progress alarm relay
- Calibration failed alarm relay
- Maintenance/Hold alarm relay

Six per unit:

- fully user-assignable and alarm relays

Rating

Voltage	250 V AC	30 V DC
Current	5 A AC	5 A DC
Loading (non-inductive)	1250 VA	150 W

Wetted materials

- PMMA (acrylic)
- PP (polypropylene)
- PTFE
- PP (20% glass filled)
- PEEK
- NBR (nitrile)
- EPDM
- Santoprene
- PTFE (15% polysulphane)
- NORYL
- Borosilicate glass
- Acrylic adhesive

Connectivity / Communications

Ethernet connection

Web server with ftp: for real time monitoring, configuration, data file access and email capability

Bus communications

Profibus DP V1 (optional)

Data handling, storage and display

Security

Multi level security: user, configuration, calibration and maintenance pages

Storage

Removable Secure Digital (SD) card

Trend analysis

Local and remote

Data transfer

SD card or FTP

Approvals, certification and safety

Safety approval

cULus

CE mark

Covers EMC & LV Directives (including latest version EN 61010)

General safety

- EN 61010–1
- Overvoltage Class 11 on inputs and outputs
- Pollution category 2

EMC

Emissions & immunity

Meets requirements of IEC61326 for an Industrial Environment

Overall dimensions

Dimensions in mm (in.)

Note. Clearance – both enclosure doors open >180°. Allow sufficient clearance if mounting in a confined area – min. 270 mm (10.6 in.) on door hinge side and 100 mm (3.9 in.) on door opening side for cables.

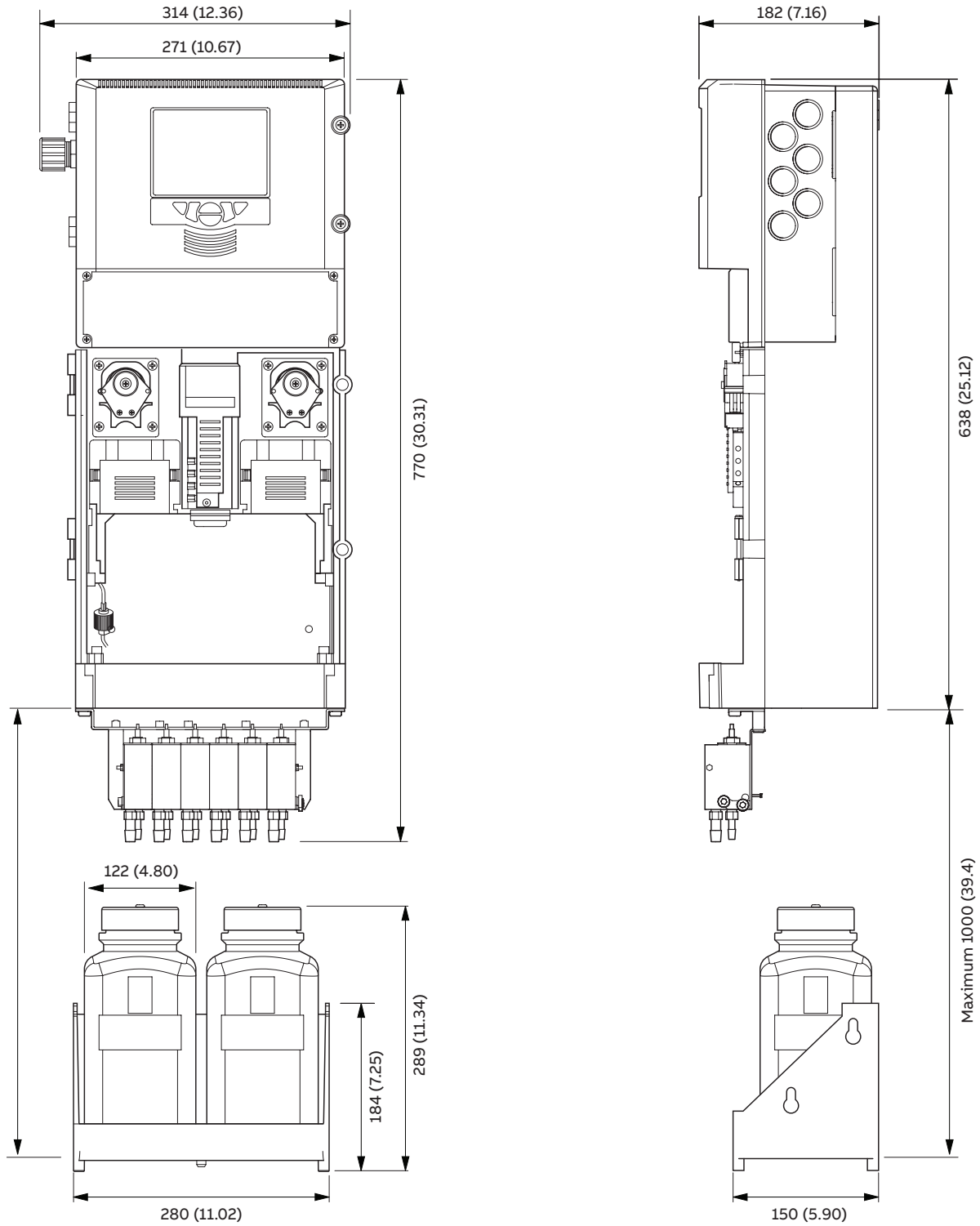

Figure 6 Navigator 600 Phosphate

...Overall dimensions

Dimensions in mm (in.)

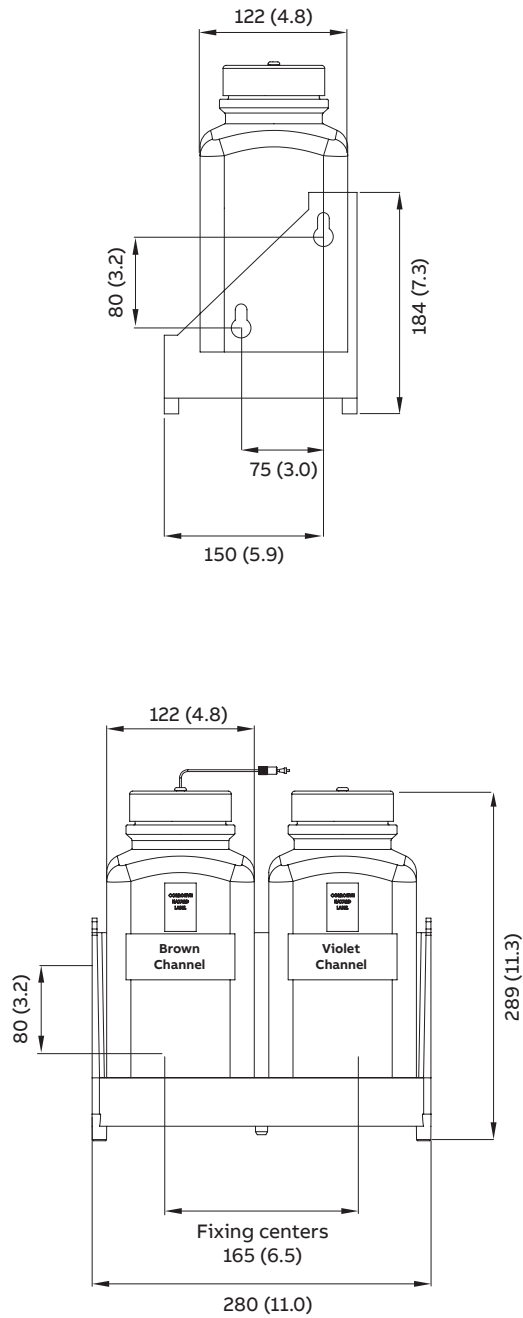

Figure 7 Reagent bottles mounted on optional bracket

Ordering information

Phosphate analyzer	AW6	4	2	/X	X	X	X	X	X	X	X
Range											
0 to 15 ppm				5							
Number of streams											
1 – Measuring 1 stream					1						
2 – Measuring 2 streams					2						
4 – Measuring 3 or 4 streams					4						
6 – Measuring 5 or 6 streams					6						
Communications											
None						0					
Profibus DP V1.0						1					
Enclosure											
Standard							0				
Standard + reagent shelves							1				
Power supply											
110 to 240 V AC / 50 to 60 Hz								0			
18 to 36 V DC								1			
Reserved											
Build									9		
Manual											
English											1
French											2
Italian											3
German											4
Spanish											5
Certification											
None											0
Certificate of calibration											1

Supplied with analyzer:

- Reagent and calibration containers

Benefits summary

- Lowest cost-of-ownership
 - up to 90 % lower reagent consumption than competitors' analyzers
 - labour-saving 5 minute annual maintenance and up to 6 months unattended operation
- Easy to use
 - familiar Windows menu system
 - built-in context-sensitive help
- Full communications
 - web- and ftp-enabled for easy data file access, remote viewing and configuration
 - optional Profibus DP V1.0
- Fast, Accurate and Reliable
 - temperature-controlled reaction and measurement section for optimum response
 - automatic cleaning, calibration and zero deliver high accuracy measurements
 - extensive electronics, measurement and maintenance diagnostics ensure high availability
- Field upgradeable
 - from 2 to 4 streams; also from 4 to 6 streams, each user-programmable from 0 to 15 ppm
- Compact size
 - 638 mm (25.1 in.) H x 271 mm (10.7 in.) W x 182 mm (7.2 in.) D
- Email facility
 - automatically email up to 6 recipients when user-selected events occur
- Grab sample facility
 - for manual sampling
- Multiple outputs and relays
 - 6 current outputs, 4 device state and 6 user-programmable relays as standard
- Archiving facility
 - SD data card for easy backup and programming
- Instrument logs
 - alarm and audit logs for complete, secure records

Acknowledgements and trademarks

Windows™, Microsoft™, MS-DOS™ and Internet Explorer™ are registered trademarks of Microsoft Corporation in the United States and / or other countries.

PROFIBUS™ is a registered trademark of PROFIBUS corporation.

Notes

Sales



Service



Software



ABB Limited

Measurement & Analytics

Oldends Lane, Stonehouse
Gloucestershire, GL10 3TA
UK

Tel: +44 (0)1453 826 661

Fax: +44 (0)1453 829 671

Mail: instrumentation@gb.abb.com

ABB Inc.

Measurement & Analytics

125 E. County Line Road
Warminster, PA 18974
USA

Tel: +1 215 674 6000

Fax: +1 215 674 7183











abb.com/measurement

We reserve the right to make technical changes or modify the contents of this document without prior notice. With regard to purchase orders, the agreed particulars shall prevail. ABB does not accept any responsibility whatsoever for potential errors or possible lack of information in this document.

We reserve all rights in this document and in the subject matter and illustrations contained therein. Any reproduction, disclosure to third parties or utilization of its contents – in whole or in parts – is forbidden without prior written consent of ABB.



Our offering:

	Actuators and Positioners		Analytical Instruments
	Device Management, Fieldbus and Wireless		Flow Measurement
	Force Measurement		Level Measurement
	Natural Gas Measurement		Pressure Measurement
	Recorders and Controllers		Temperature Measurement

HMI – Automação e Instrumentação, Lda.

Travessa da Indústria, nº 111
4780-573 Santo Tirso
PORTUGAL

Tel. +351 252 850 501
Fax. +351 300 013 487

Web: www.hmi.pt

Email: hmi@hmi.pt