

# hmi

high-accuracy  
measurement  
instruments

FICHA TÉCNICA DE PRODUTO

PRODUCT DATASHEET

---

**HMI – Automação e Instrumentação, Lda.**

---

Travessa da Indústria, nº 111  
4780-573 Santo Tirso  
PORTUGAL

Tel. +351 252 850 501  
Fax. +351 300 013 487

Web: [www.hmi.pt](http://www.hmi.pt)

Email: [hmi@hmi.pt](mailto:hmi@hmi.pt)

ABB MEASUREMENT & ANALYTICS | DATA SHEET

# Aztec 600 Aluminium

## Aluminium analyzer



---

## Measurement made easy

Reliable on-line monitoring of aluminium for potable water applications

### Reliable aluminium measurement

- automatic 2-point calibration
- automatic sample dilution to maximize range
- automatic background color compensation
- analysis of up to 3 sample streams

### Easy to operate

- familiar Windows™ menu system
- built-in context-sensitive help
- data trending and analysis

### Easy to maintain

- self-cleaning measurement cell
- simple-to-perform annual service
- helpful maintenance diagnostics screens

### Full communications

- web- and ftp-enabled for easy data file access, remote viewing and configuration
- email capability
- optional Profibus® DP V1.0

## Introduction

The Aztec 600 colorimetric series of analyzers from ABB are a range of compact, yet reliable, on-line colorimetric analyzers for the key parameters in water treatment.

They combine the unique Aztec fluid handling system with the latest electronics platform, featuring Windows menu-driven software, to create a range of analyzers simple-to-operate and maintain; capable of measuring up to three sample streams.

The Aztec 600 Aluminium analyzer has been designed specifically for the measurement of aluminium in potable water applications. It offers reliable and accurate, on-line analysis of aluminium up to 2 ppm.

All the sample and chemical fluid handling for measurement, mixing and disposal is controlled precisely by the patented Aztec fluid handling system that cleans the measuring cell with every movement.

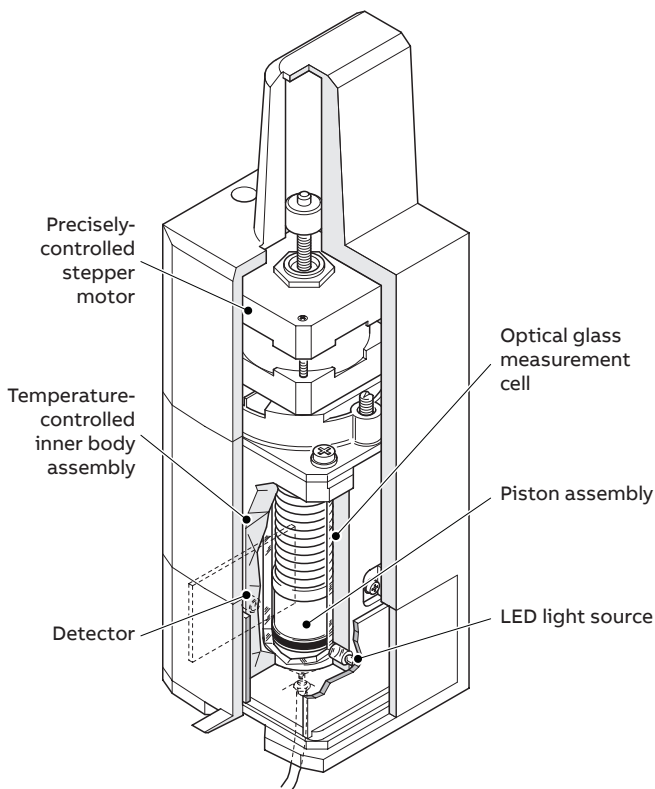

Measuring head detail

Users of this system also benefit from the Aztec 600 Aluminium's low maintenance requirements, ease of use, auto-calibration, adjustable frequency of measurement and proven chemistry methodology.

Process data, as well as the content of alarm and audit logs, can be saved to a removable SD card for record keeping and analysis using ABB's DataManager data analysis software.

## User benefits of on-line aluminium monitoring

The task of managing the quantity of water resources and the quality of drinking water today is unimaginable without on-line instrumentation that helps water utilities manage, treat and deliver drinking water to consumers.

On-line monitoring provides plant operators with an early warning of any changes to the treatment process, enabling operational decisions to be made in near real-time. This level of process control is not possible with manual testing alone, where potentially important events that occur between less frequent manual sampling can be missed.

### Users of the Aztec 600 Aluminium analyzer benefit from:

- Improvements in process control
  - enables operational decisions to be made in near real-time.
- Improvements in process reliability
  - detect process failures before they affect the quality of the water leaving the plant.
- Process optimization for water quality
  - increased plant efficiency.
- Potential capital and operating cost reductions
  - reduction in chemical and energy usage.
- Continual monitoring of remote or un-staffed sites
  - improved response times and reduced visits saving money and time whilst lowering carbon footprint.
- Improved reporting
  - analyzer audit trail data can be used to assure customers and regulators of process efficiency and consistent product quality.

## Applications

Typical applications for the Aztec 600 Aluminium are:

- Monitoring of aluminium-based coagulants used in drinking water:
  - monitoring of aluminium residuals in surface waters treated with aluminium-based coagulants to help optimize the coagulation process and ensure final aluminium residuals in treated water comply with legislation
  - monitoring of the effluent discharge from the sludge holding tanks

# Overview of the Aztec 600 Aluminium analyzer

### Easy-to-use Windows-based menu system



### Graphical trending of results

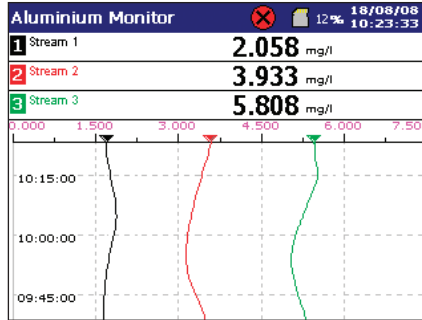

### Flexible communications

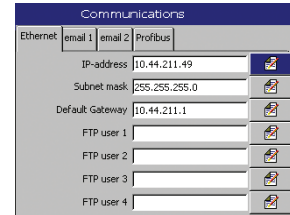

- Ethernet connectivity
- 6 mA outputs
- 10 Alarm relays (configurable)
- Profibus DP v1.0
- SD Memory Card
- Process data trends

### Simple navigation

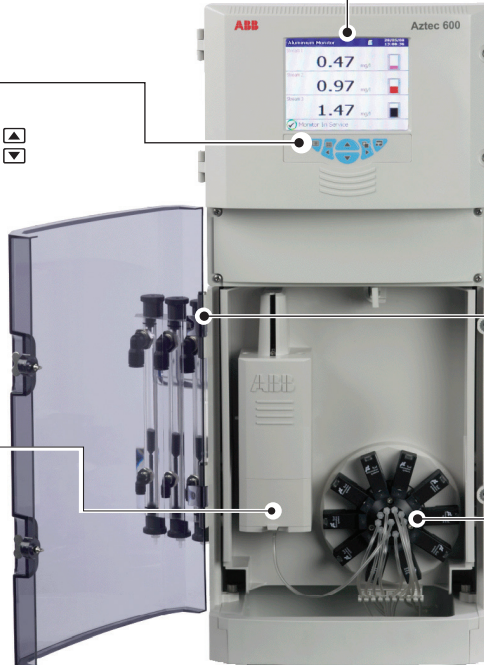
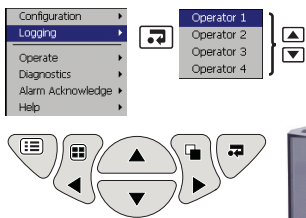

### Advanced optics

- Automatic LED intensity adjustment at every calibration – eliminates drift and compensates for any cell fouling
- Temperature-controlled for optical stability
- Automatic 2-point calibration
- Automatic sample dilution to maximize measurement range
- Background sample color compensated for

### Single- or multi-stream options

- Integrated side-sample pot for ease of plumbing
- Magnetic sample flowswitch alarms when sample is not present

### Simplified fluid handling

- Single piston pump draws in precise volumes of reagents and samples through a valve manifold into the optical measuring cell
- Air is used in the chemical sequence for mixing and purging the reagents and sample
- Piston movement provides mechanical cleaning the measurement cell

## Reliable measurement

The Aztec 600 Aluminium is an on-line colorimetric analyzer. It has been designed for ease-of-use and maintenance simplicity, while offering the benefits of flexible communication and advanced data acquisition.

The Aztec 600 Aluminium can measure up to 6 samples per hour using the industry standard PCV (pyrocatechol violet) reaction chemistry, measuring the soluble aluminium content.

A fully-programmable multi-stream option is available, providing up to 3-stream capability with user-programmable stream sequencing.

### Fluid handling

A single piston pump provides all the sample and chemical fluid handling for measurement, mixing and disposal. The pump is stepper motor controlled for repeatability and precision.

This 'motorized syringe' approach has the added benefit of wiping the optical cell on every movement of the piston, resulting in a highly efficient automatic cleaning process.

This is particularly important when measuring waters where optical contamination can be a real issue without having stringent automatic cleaning.

### Measurement technique

The optical cell is rinsed thoroughly with sample before measurement, eliminating dead zones and enabling multi-stream measurement across different samples without cross contamination.

To correct for any natural coloration of the sample, the background absorbance of the sample is measured prior to the addition of any color-forming reagents to provide a sample blank.

The sample then undergoes a warm acid digest in the temperature-controlled optical measurement cell for 5 minutes. This pre-treatment step is usually sufficient to convert all forms of aluminium to those that react with the color-forming PCV reagent that is added last.

Instead of using a mechanical stirring system, the piston and optical sensor is utilized further by drawing in air after the sample and reagents are introduced. This provides turbulence and efficient mixing without any of the cost and maintenance drawbacks of mechanical and electrical mixing systems.

The Aztec 600 Aluminium analyzer has the capability to enable an automated chemical cleaning routine. This programmable rinse routine enables a separate acid / alkali or biocide to be drawn through the sample tubing and optical cell.

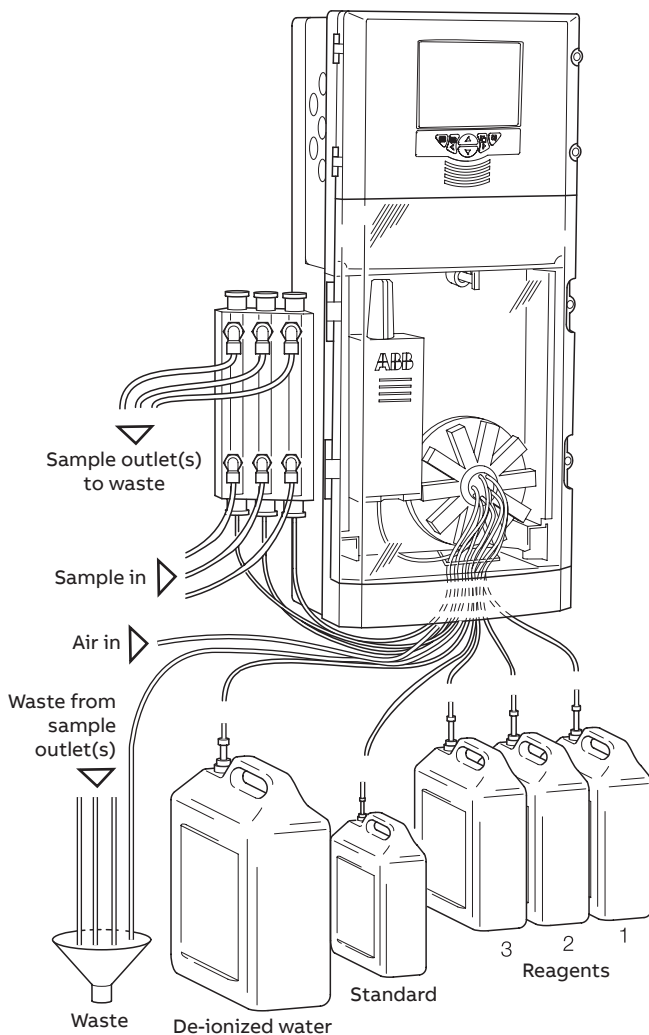

Example of multi-stream installation

## Simple to operate

The powerful and user-friendly Windows menu-driven software enables user's to operate the analyzer with the minimum amount of training.

The comprehensive range of available menu screens is simple-to-access using the 6 membrane keys.



Windows-based interface

These menus include data logging and graphical trending screens, operation command screens, full setup configuration screens and a range of self-diagnostics (including full calibration and operating status screens).

Historical logs provide operators with access to alarm logs and audit trail data. Process data and historical logs are archived securely to a removable SD card.

All information is displayed clearly on the easy to read 145 mm (5.7 in.) color LCD display and is available in a range of languages.

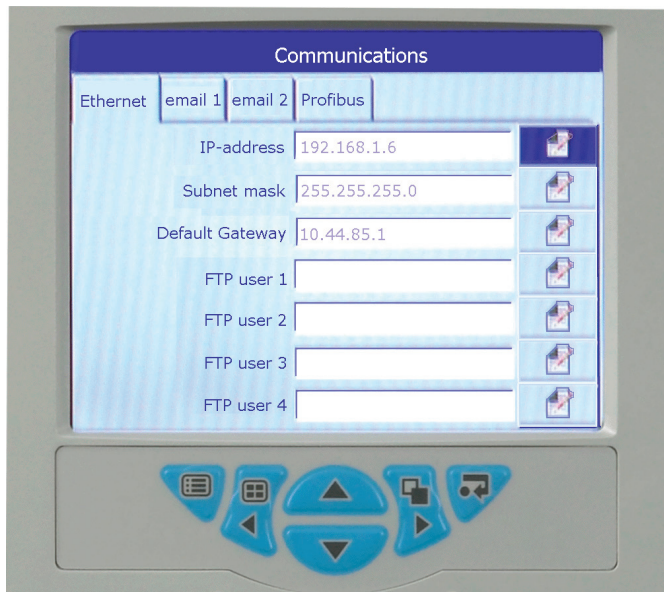

Communications window

## Simple to maintain

The Aztec 600 colorimetric range is designed to be as maintenance-free as possible. The inherent product design and auto-calibrating features reduce the amount of maintenance required to external cleaning of sample lines, changing of reagents and annual servicing.

### Service schedule

Period	Schedule
12 monthly	Replace piston assembly and sample tubing.
24 monthly	Replace valve diaphragms, piston assembly and monitor tubing.

All parts are provided in convenient maintenance kits.

### Solution replacement

The Aztec 600 Aluminium analyzer uses a total of approximately 25 ml of sample, per analysis: 7.5 ml for the actual measurement and the remainder for cell rinsing. The automatic 2-point calibration substitutes the sample with the calibration solutions at the same amount.

Above 0.300 ppm Al the Aztec 600 Aluminium dilutes samples automatically with de-ionised water, to maximize the measurement range. The dilution ratio between sample and de-ionised water is user-configurable between: 1:1, 1:2, 1:3, 1:4.

Dilution ratio	Approximate volume of de-ionised water used per measurement
1:0	0 ml
1:1	12.5 ml
1:2	16.5 ml
1:3	19 ml
1:4	20 ml

A standard set of reagents consists of three reagents (5 litres of each) and a high standard (2.5 l). The reagent usage depends on how many samples per hour are being measured.

Samples per hour	Duration of reagent set (days)
6	40
4	60
3	80
2	120
1	240

## Flexible communications

### Ethernet-ready

The Aztec 600 provides 10BaseT Ethernet communications via a standard RJ45 connector and uses industry-standard protocols TCP/IP, FTP and HTTP. The use of standard protocols enables easy connection into existing PC networks.

### Data file access via FTP (File Transfer Protocol)

The Aztec 600 features FTP server functionality. The FTP server in the analyzer is used to access its file system from a remote station on a network. This requires an FTP client on the host PC. Both MS-DOS® and Microsoft® Explorer version 5.5 or later can be used as an FTP client.

- Using a standard web-browser or other FTP client, data files contained within the analyzer's memory or memory card can be accessed remotely and transferred to a PC or network drive.
- Four individual FTP users' names and passwords can be programmed into the Aztec 600. An access level can be configured for each user.
- All FTP log-on activity is recorded in the audit log of the analyzer.
- Using ABB's data file transfer scheduler program, data files from multiple analyzers can be backed-up automatically to a PC or network drive for long-term storage, ensuring the security of valuable process data and minimizing the operator intervention required.

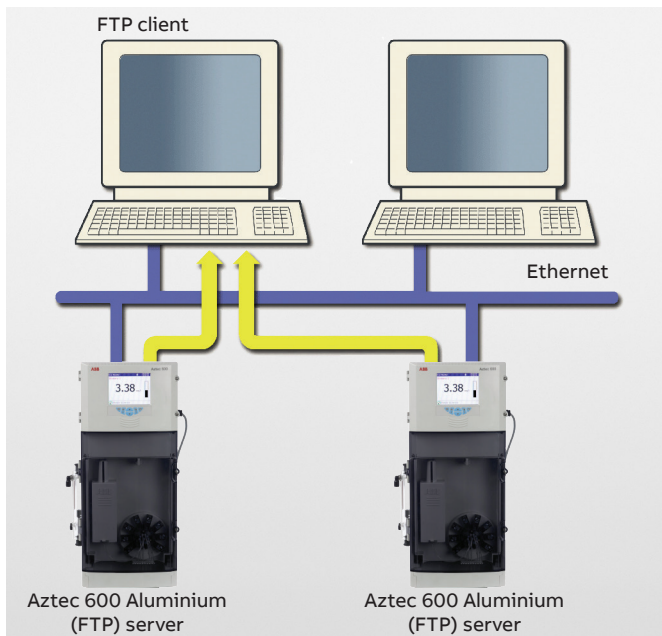

### Embedded web server

The Aztec 600 Aluminium has an embedded web-server that provides access to web pages created within the analyzer. The use of HTTP (Hypertext Transfer Protocol) enables standard web browsers to view these pages.

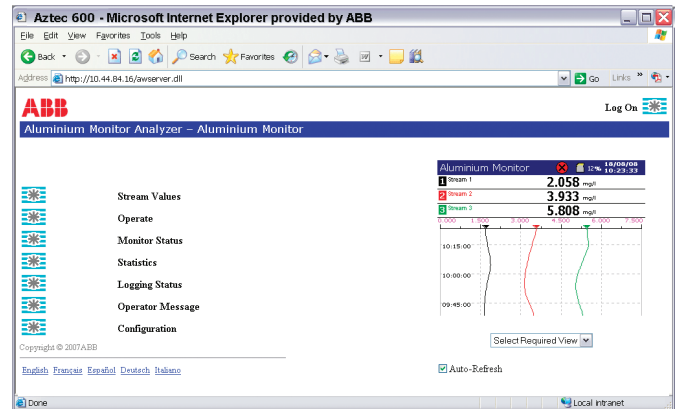

- Accessible through the web pages are the current display of the analyzer, detailed information on stream values, reagent and solution levels, measurement status and other key information.
- The audit and alarm logs stored in the analyzer's internal buffer memory can be viewed on the web pages.
- Operator messages can be entered via the web server, enabling comments to be logged to the analyzer.
- The web pages and the information they contain are refreshed regularly, enabling them to be used as a supervision tool.
- The analyzer's configuration can be selected from an existing configuration in the internal memory or a new configuration file transferred to the analyzer via FTP.
- The analyzer's real-time clock can be set via the web server. Alternatively, the clocks of multiple analyzers can be synchronized using ABB's File Transfer Scheduler software.

### E-mail notification

Via the Aztec 600 Aluminium's built-in SMTP client, the analyzer is able to e-mail notification of important events. E-mails triggered from alarms or other critical events can be sent to multiple recipients. The analyzer can also be programmed to email reports of the current measurement status or other parameters at specific times during the day.

### Profibus

The Aztec 600 Aluminium can be equipped with Profibus DP V1.0 to enable full communications and control integration with distributed control systems.

## Specification

### Measurement range

#### Aluminium

Auto-ranging	0 to 1.500 ppm Al
Undiluted range	0 to 0.300 ppm Al
Diluted range	0.3 to 1.500 ppm Al

### Chemical method

#### Aluminium

Pyrocatechol Violet (PCV)

#### Background color correction

Compensated at the measurement wavelength

#### Self-cleaning

Programmable automatic chemical rinsing – piston cleaned every measurement

### Measurement mode

#### Batch measurement

User-selectable 1 to 6 measurements per hour

#### Sample streams

Single or up to 3 streams – sequencing is programmable

### Measurement performance

#### Accuracy<sup>1</sup>

<±5 % of reading<sup>2</sup> or ±0.005 ppm  
(whichever is the greater)

#### Repeatability

<±5 % of reading<sup>3</sup> or ±0.005 ppm  
(whichever is the greater)

#### Resolution

0.001 ppm or 1 ppb

#### Measurement units

mg/l, ppm, ppb, µg/l

#### Calibration

2-point, automatic calibration, with the option of manual initiation. The interval between automatic calibrations manually selectable from four times a day to once per week.

### Environmental data

#### Ambient operating temperature

5 to 45 °C (41 to 113 °F)

#### Ambient operating humidity

Up to 95 % RH non-condensing

#### Sample temperature

1 to 40 °C (32 to 104 °F)

#### Sample flow

Continuous, 200 to 500 ml/min

#### Sample pressure

5 psi maximum

#### Sample limitations

Samples containing particles 100 microns (0.004 in.) in diameter or larger may require pre-filtration.

### Maintenance

#### Routine service interval

12 months

#### Reagent consumption

0.75 ml of each reagent per measurement

### Display

- Color, TFT, liquid crystal display (LCD) with built-in backlight and brightness adjustment
- Diagonal display area 145 mm (5.7 in.)
- 76800 pixel display\*

\* A small percentage of the display pixels may be either constantly active or inactive. Max. percentage of inoperative pixels <0.01 %.

#### Dedicated operator keys

- Group select / left cursor
- View select / right cursor
- Menu key
- Up / Increment key
- Down / Decrement key
- Enter key

<sup>1</sup> Maximum measured error across full measurement range.

<sup>2</sup> Tested in accordance with IEC 61298 Parts 1-4 : Edition 2.0 2008-10.

<sup>3</sup> Tested in accordance with BS ISO 15839 : 2003.

## Mechanical data

### Ingress protection

IP31\*\*

### Sample connections

Inlet: 6 mm OD push-fit x ¼ in. BSP elbow  
 Outlet: 10 mm OD push-fit x ¾ in. BSP elbow

### Dimensions

Height 653 mm (25.7 in.)  
 Width 366 mm (14.4 in.) max.  
 Depth 183 mm (7.2 in.) door closed  
 430 mm (16.9 in.) door open  
 Weight 15 kg (33 lb)

### Materials of construction

Electronics enclosure 10 % glass loaded polycarbonate  
 Main enclosure Noryl  
 Lower tray 20 % glass loaded polypropylene  
 Door Acrylic

## Electrical

### Power supply ranges

- 100 to 240 V max. AC, 50 / 60 Hz ± 10 %  
 (90 to 264 V AC, 45 / 65 Hz)
- 18 to 36 V DC (optional)

### Power consumption

75 W max. – AC  
 100 W max. – DC

## Analog outputs

### Single and multi-stream analyzers

6 isolated current outputs, fully assignable and programmable over a 0 to 20 mA range (up to 22 mA if required)

## Alarms / Relay outputs

### Single- and multi-stream analyzers

One per unit:

- Stop relay
- Attention relay
- Failure relay
- Calibrate relay

Six per unit:

- Fully user-assignable alarm relays

### Rating

Voltage	250 V AC	30 V DC
Current	5 A AC	5 A DC
Loading (non-inductive)	1250 VA	150 W

## Connectivity / Communications

### Ethernet connection

Web server with FTP – for real-time monitoring, configuration, data file access and email capability

### Communications

Profibus DP V1.0 (optional)

## Data handling, storage and display

### Security

Multi level security Operator and configuration password or security switch

### Storage

Removable Secure Digital (SD) card

### Trend analysis

Local and remote

### Data transfer

SD card or FTP

## Approvals, certification and safety

### Safety approval

cULus

### CE Mark

Covers EMC & LV Directives (including latest version EN 61010)

### General safety

- EN61010-1
- Overvoltage Class II on inputs and outputs
- Pollution category 2

## EMC

### Emissions & immunity

Meets requirements of IEC61326 for an industrial environment

## Overall dimensions

Dimensions in mm (in.)

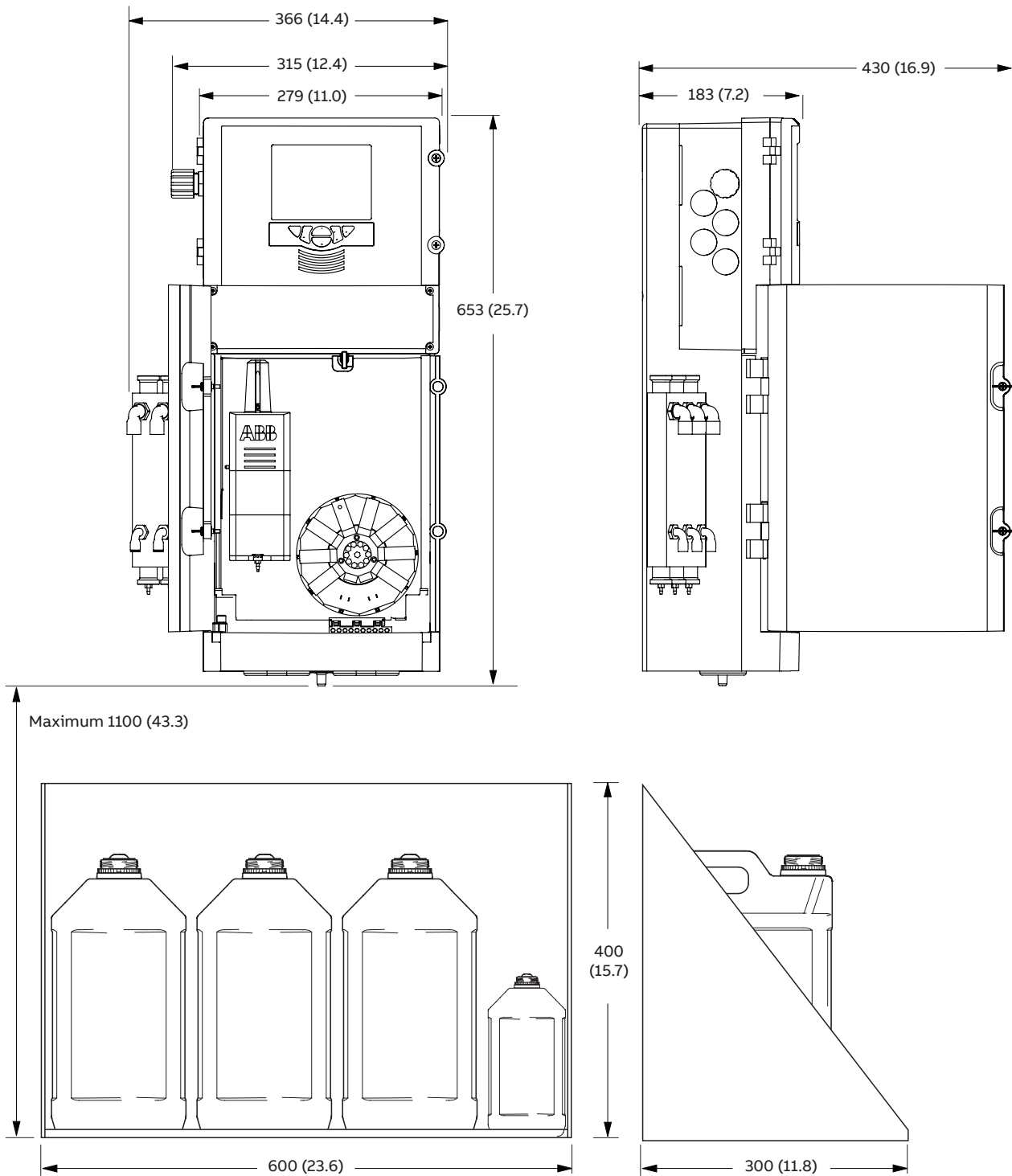

Overall dimensions of Aztec 600 analyzer and optional reagent support tray

## Electrical connections

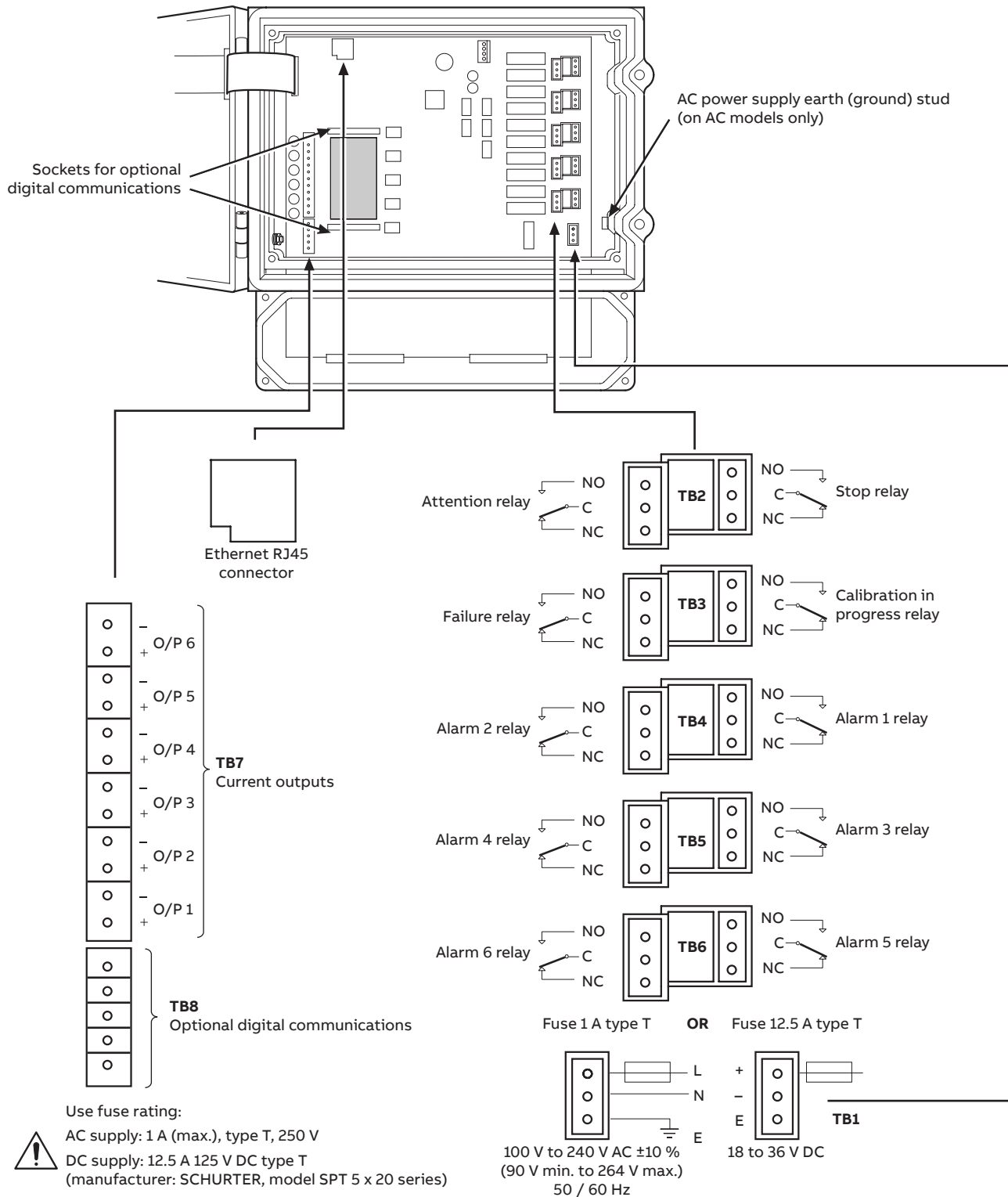

## Ordering information

Aztec 600 Aluminium analyzer	AW631	X	X	X	X	X	0	X	X
<b>Range</b>									
0 to 1.500 ppm	5								
<b>Number of streams</b>									
Measuring 1 stream			1						
Measuring 1 stream with additional valve for cleaning			2						
Measuring 3 streams			3						
<b>Communications</b>									
None				0					
Profibus DP V1.0				1					
<b>Enclosure</b>									
Standard					0				
<b>Power supply</b>									
90 to 264 V AC / 50 to 60 Hz						0			
18 to 36 V DC						1			
<b>Reserved</b>								0	
<b>Manual</b>									
English									1
French									2
Italian									3
German									4
Spanish									5
<b>Certification</b>									
None									0
Certificate of calibration									1

## Accessories

Reagent support tray (stainless steel) – part no. 03-0051-A

---

## Acknowledgements and trademarks

Windows, Microsoft, MS-DOS and Internet Explorer are registered trademarks of Microsoft Corporation in the United States and/or other countries.

Profibus® is a registered trademark of Profibus International.

Sales



Service



Software





## Notes



---

**ABB Limited**

**Measurement & Analytics**

Oldends Lane, Stonehouse  
Gloucestershire, GL10 3TA  
UK

Tel: +44 (0)1453 826 661

Fax: +44 (0)1453 829 671

**ABB Inc.**

**Measurement & Analytics**

125 E. County Line Road  
Warminster, PA 18974

USA

Tel: +1 215 674 6000

Fax: +1 215 674 7183

**[abb.com/measurement](http://abb.com/measurement)**











---

We reserve the right to make technical changes or modify the contents of this document without prior notice. With regard to purchase orders, the agreed particulars shall prevail. ABB does not accept any responsibility whatsoever for potential errors or possible lack of information in this document.

We reserve all rights in this document and in the subject matter and illustrations contained therein. Any reproduction, disclosure to third parties or utilization of its contents – in whole or in parts – is forbidden without prior written consent of ABB.



## Our offering:

	Actuators and Positioners		Analytical Instruments
	Device Management, Fieldbus and Wireless		Flow Measurement
	Force Measurement		Level Measurement
	Natural Gas Measurement		Pressure Measurement
	Recorders and Controllers		Temperature Measurement

---

## HMI – Automação e Instrumentação, Lda.

---

Travessa da Indústria, nº 111  
4780-573 Santo Tirso  
PORTUGAL

Tel. +351 252 850 501  
Fax. +351 300 013 487

Web: [www.hmi.pt](http://www.hmi.pt)

Email: [hmi@hmi.pt](mailto:hmi@hmi.pt)